

Stonehenge

英格兰威尔特郡巨石阵



Front

Left

Back

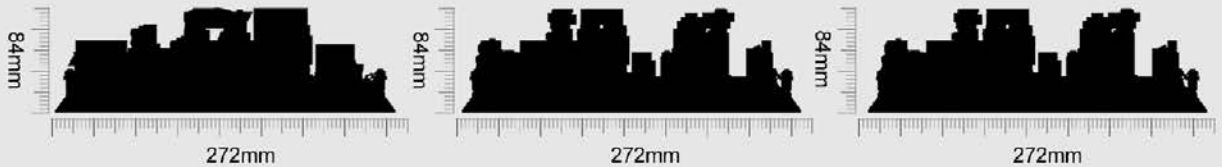

Product Size: 272X272X84mm



Instructions For Use

积木起件器使用说明
Brickseparator

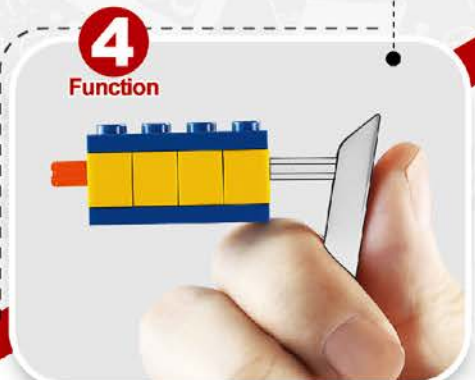
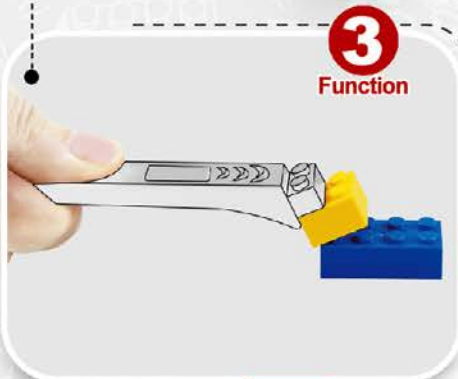
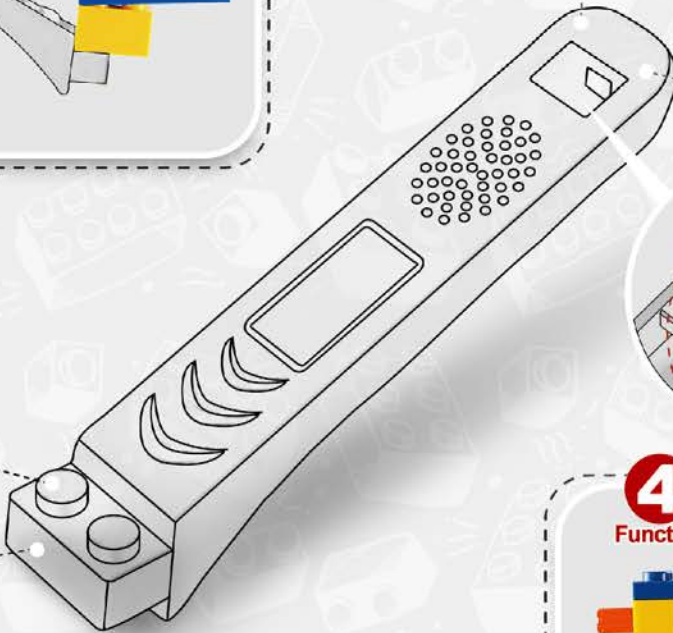
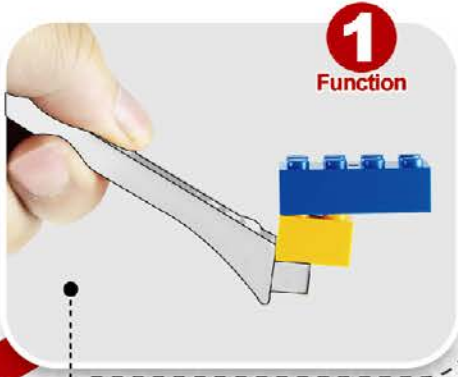

4 ways to make installation easier

让安装更简单



- First open the product packaging according to the instructions.

按指导用正确方式拆解产品外包装。



- Summarize all parts to count the number of familiar accessories.

对照说明书清单确认积木包数量与积木数量。



- Arranging all accessories by color helps to quickly install the product.

把确认好的积木以类型、颜色进行分类排好以便安装。



- Carefully install the product and learn about building.

按说明书步骤拼装并完成你的积木模型。



1:1 Physical Reference Table

十字棒配件1:1尺寸参照表

1:1

Instructions For Use

让安装更简单



2 (1x2)=2



3 (1x3)=3



4 (1x4)=4



5 (1x5)=5



6 (1x6)=6



7 (1x7)=7

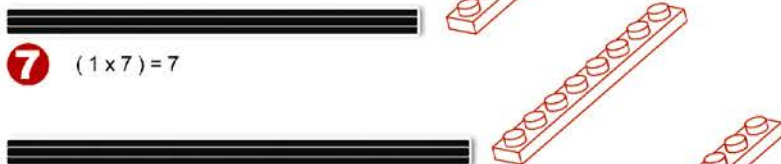

8 (1x8)=8

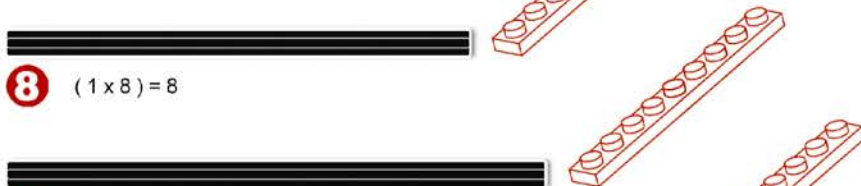

9 (1x9)=9



10 (1x10)=10



12 (1x12)=12















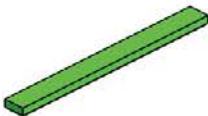

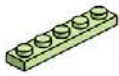



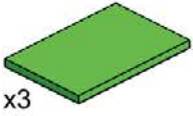

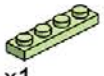
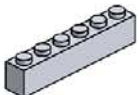



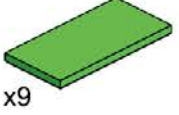

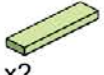
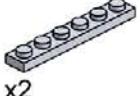



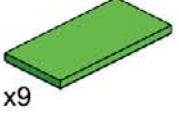

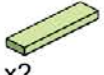
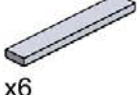



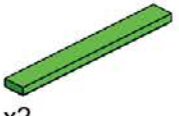



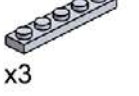



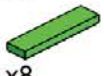
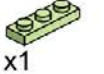
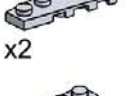



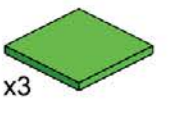

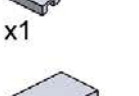













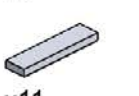



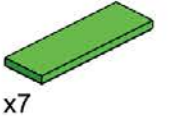

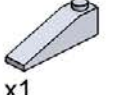



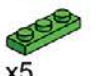

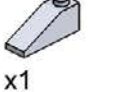









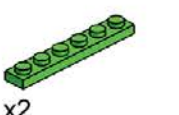



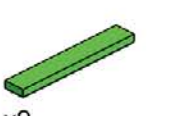

















16 (1x16)=16



PARTS LIST

配件清单

						
x4	x3	x1	x14	x1	x3	x1
						
x1	x1	x1	x6	x3	x6	x1
						
x1	x2	x7	x1	x9	x1	x2
						
x2	x1	x11	x5	x9	x2	x2
						
x6	x6	x3		x2	x4	x1
						
x3	x2	x5	x14	x2	x8	x1
						
x2	x10	x5	x1	x3	x6	x3
						
x1	x1	x3		x1	x1	x5
						
x1	x3	x2	x16	x7	x22	x4
						
x3	x3	x16	x7	x7	x5	x1
						
x11	x1	x7	x1	x2	x12	x3
						
x1	x3	x19	x7	x8	x4	x4
						
x1	x5	x4	x7	x2	x1	x7
						
						
						
						
						
						
						
						
						

产品有增补件请以实物为准

If product has additional parts, please in kind prevail.

PARTS LIST

配件清单

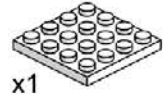
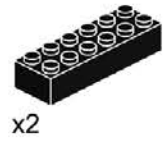
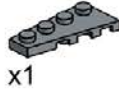
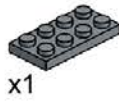
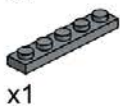
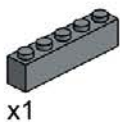
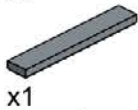
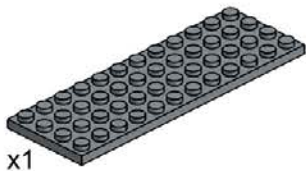
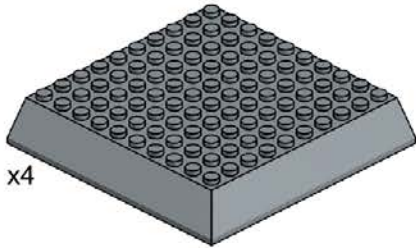

产品有增补件请以实物为准

If product has additional parts, please in kind prevail.

Helpful Tips: This product uses UV pressure transfer stickers, which can enhance the product's aesthetics and hands-on fun.

温馨小提示：本套产品采用UV感压转印贴纸，更能提高产品的美观度和动手乐趣。

😊 Steps for transferring stickers:

转印贴纸3步骤：

- ① Tear off the desired pattern and stick it on the building blocks that need to be transferred.
撕下所需图案，贴上要转印的积木砖块上；
- ② Use your finger or an appropriate tool to evenly scrape the pattern on the sticker surface for transfer.
用手指或相应工具在贴纸表面均匀刮擦图案进行转印；
- ③ Gently tear off the top transparent film layer to complete the transfer.
轻轻撕开表层透明膜，完成转印。

😊 The following are the building blocks in the second package that need to be attached with transfer stickers.

Please stick the stickers to the corresponding parts before continuing with the assembly.

以下为第二分包内需要贴转印贴纸的积木砖块，拼搭前请先将贴纸贴到对应的配件上后再继续进行。

- ① The following parts require double-sided transfer stickers (Note: after attaching the stickers according to the corresponding sticker number, gently tear them off according to the steps to successfully transfer the pattern.)

以下配件需**双面**贴转印贴纸（注：按照相应的贴纸编号，贴上后再按步骤轻轻撕下，即可成功转印图案）

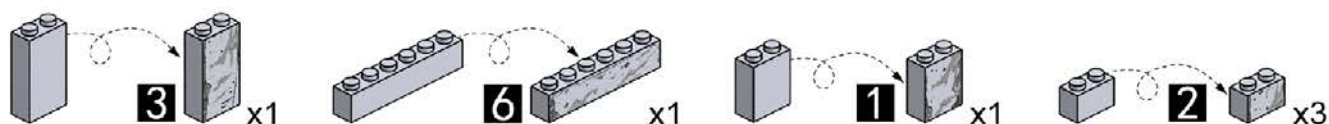

- ② The following parts require single-sided transfer stickers (Note: after attaching the stickers according to the corresponding sticker number, gently tear them off according to the steps to successfully transfer the pattern.)

以下配件需**单面**贴转印贴纸（注：按照相应的贴纸编号，贴上后再按步骤轻轻撕下，即可成功转印图案）

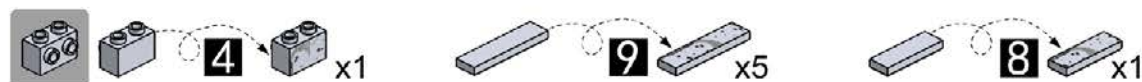

😊 The following are the building blocks in the third package that need to be attached with transfer stickers.

Please stick the stickers to the corresponding parts before continuing with the assembly.

以下为第三分包内需要贴转印贴纸的积木砖块，拼搭前请先将贴纸贴到对应的配件上后再继续进行。

- ① The following parts require double-sided transfer stickers (Note: after attaching the stickers according to the corresponding sticker number, gently tear them off according to the steps to successfully transfer the pattern.)

以下配件需**双面**贴转印贴纸（注：按照相应的贴纸编号，贴上后再按步骤轻轻撕下，即可成功转印图案）

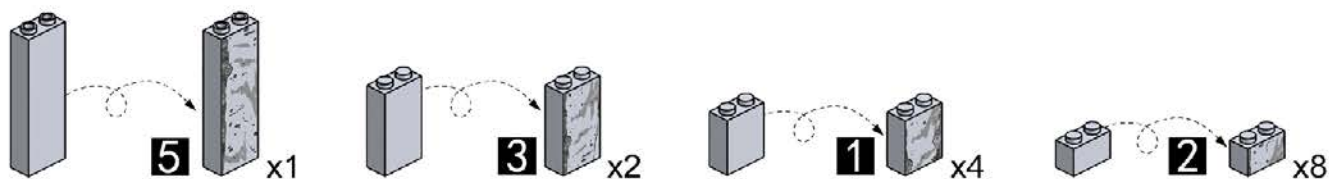

- ② The following parts require single-sided transfer stickers (Note: after attaching the stickers according to the corresponding sticker number, gently tear them off according to the steps to successfully transfer the pattern.)

以下配件需**单面**贴转印贴纸（注：按照相应的贴纸编号，贴上后再按步骤轻轻撕下，即可成功转印图案）

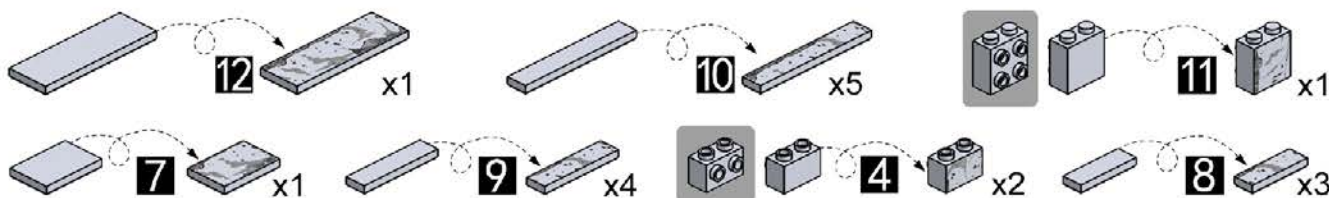



234PCS

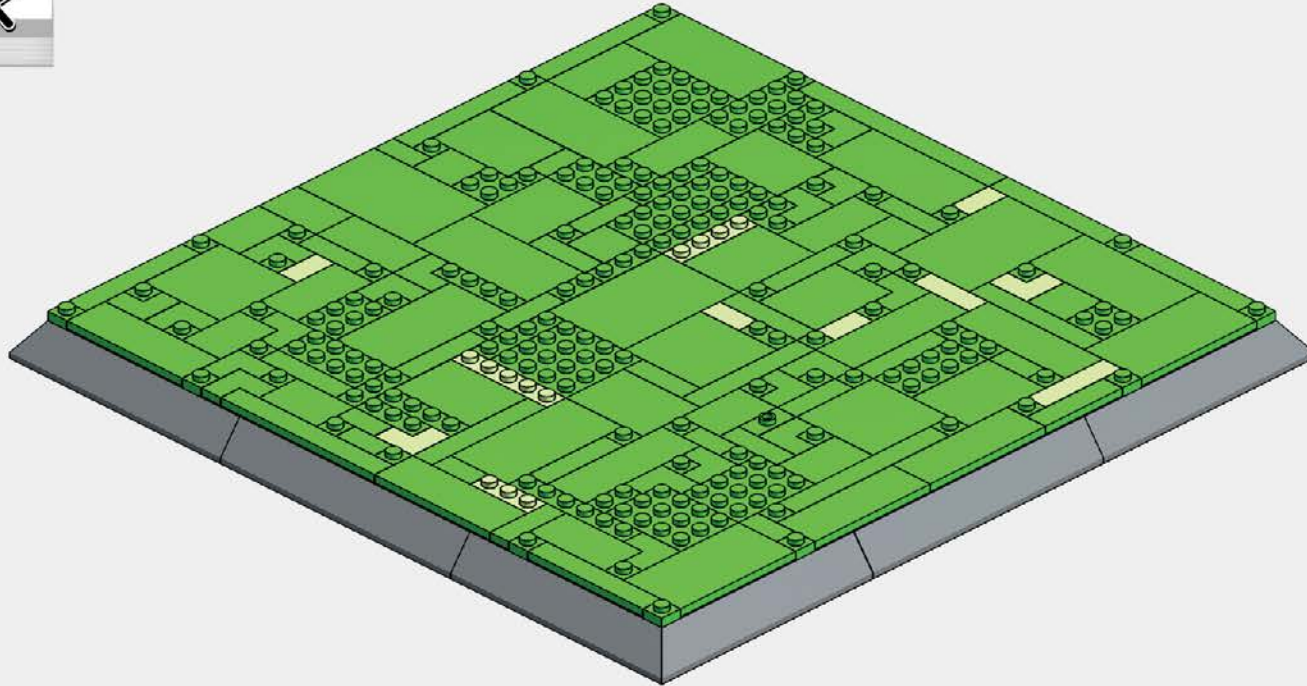

1-1



微信扫一扫
补件更简单

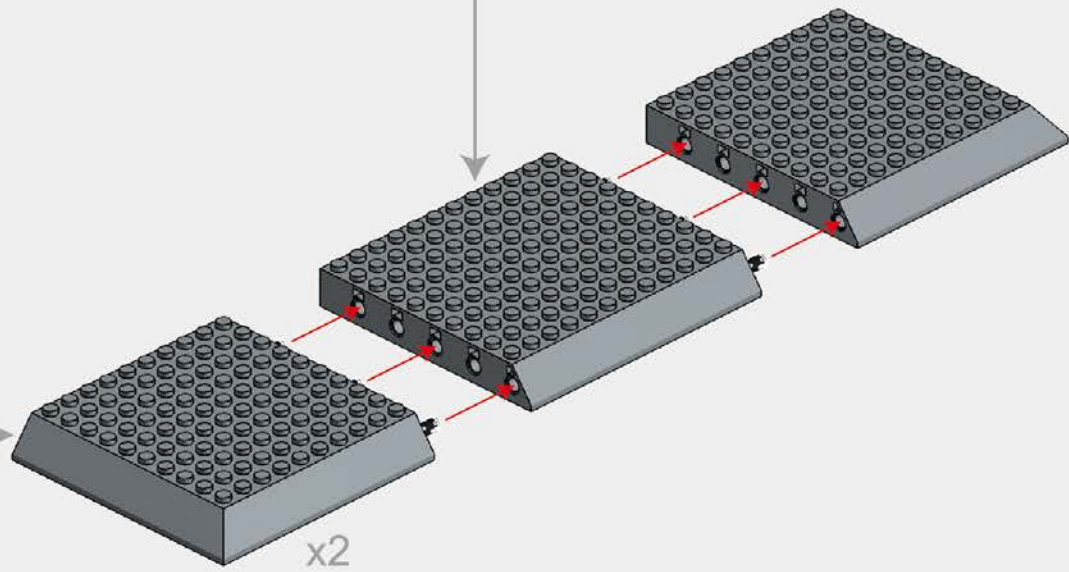
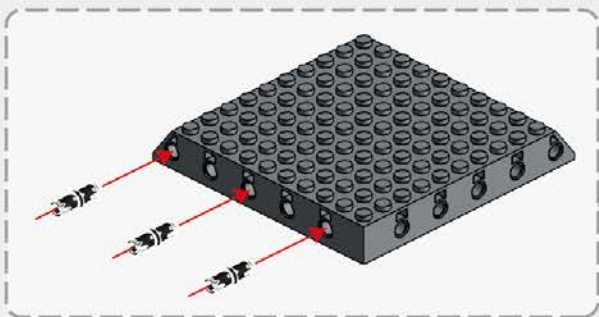
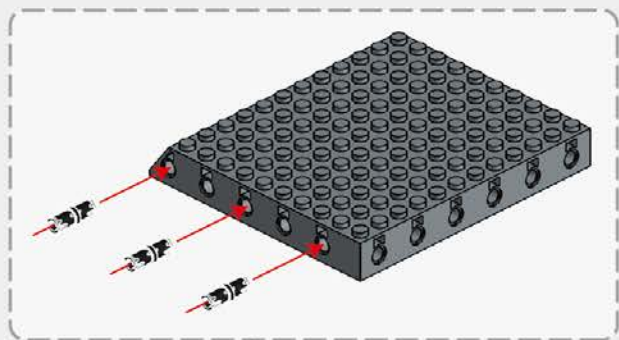
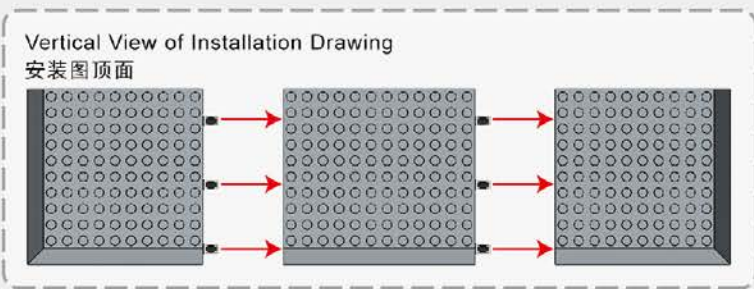
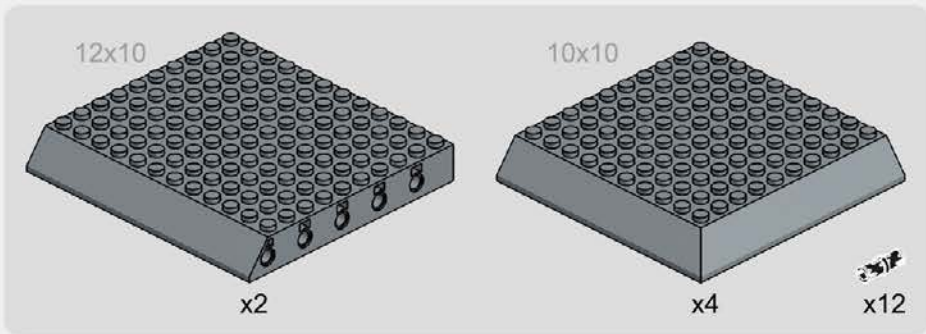

1-2

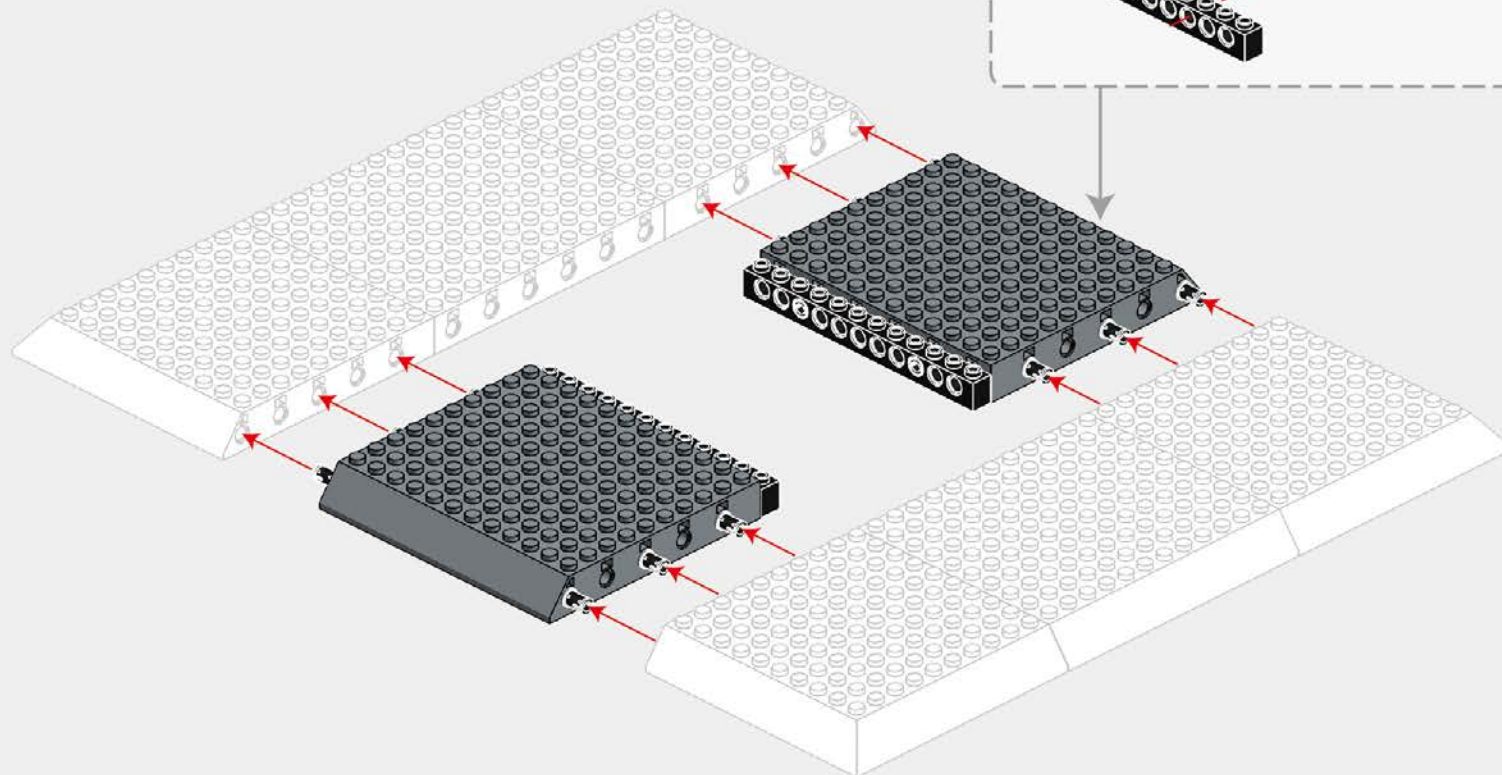
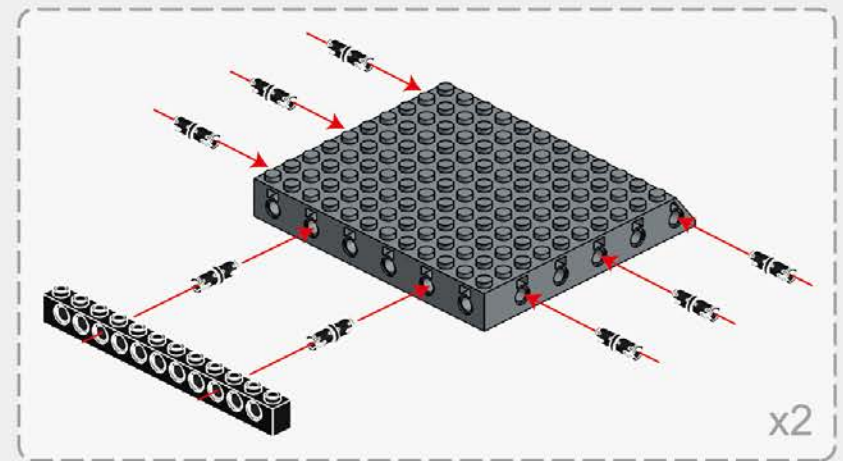
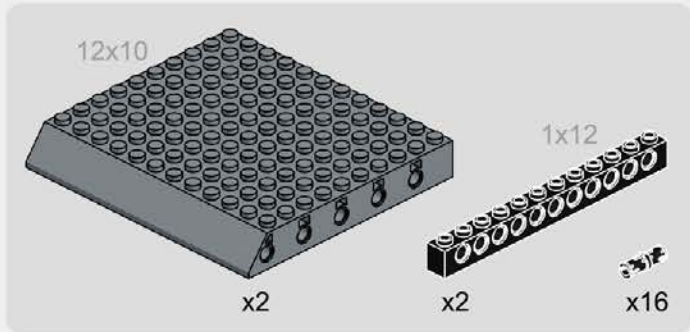

1-3

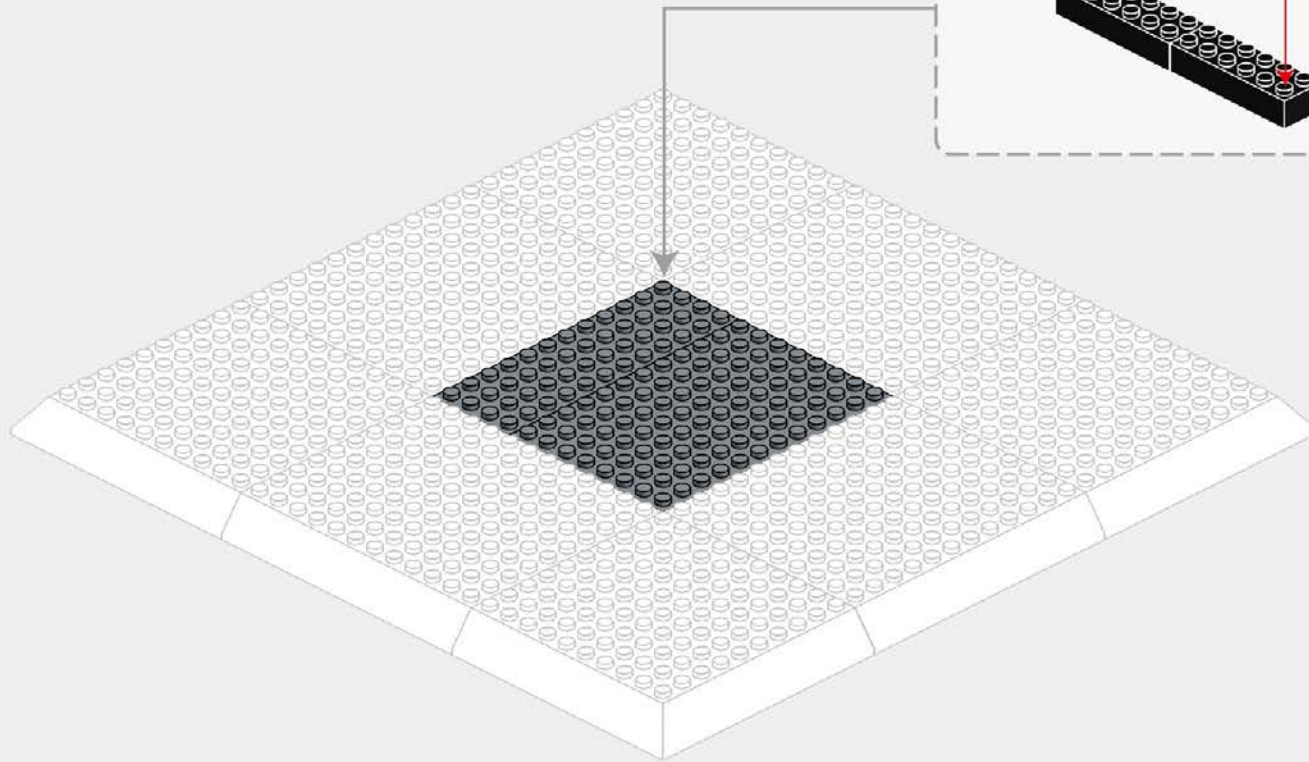
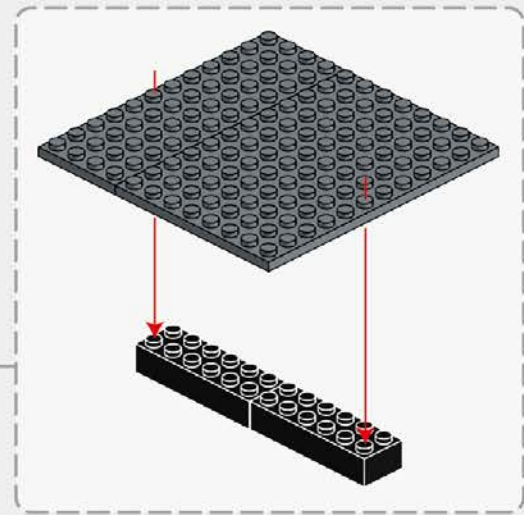
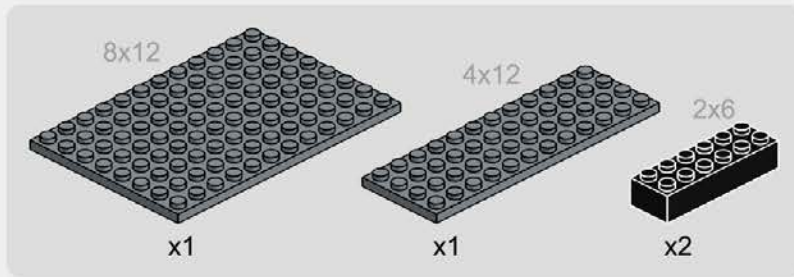

1-4

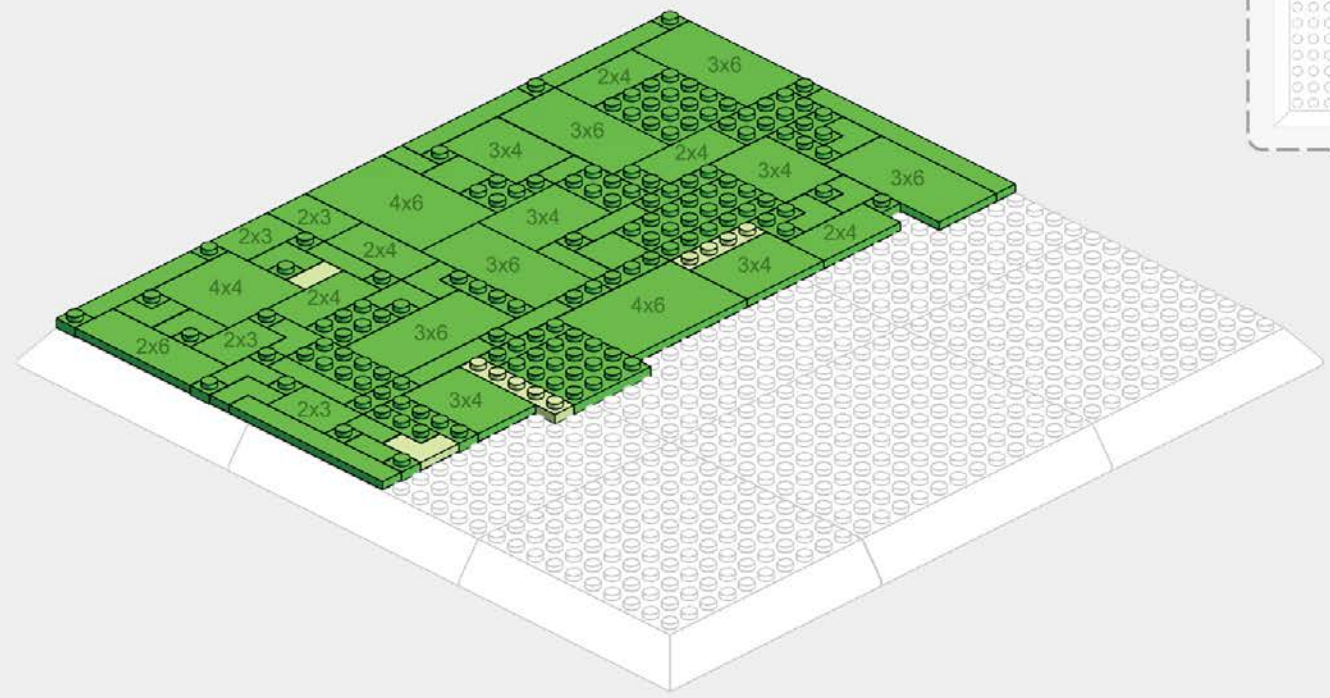
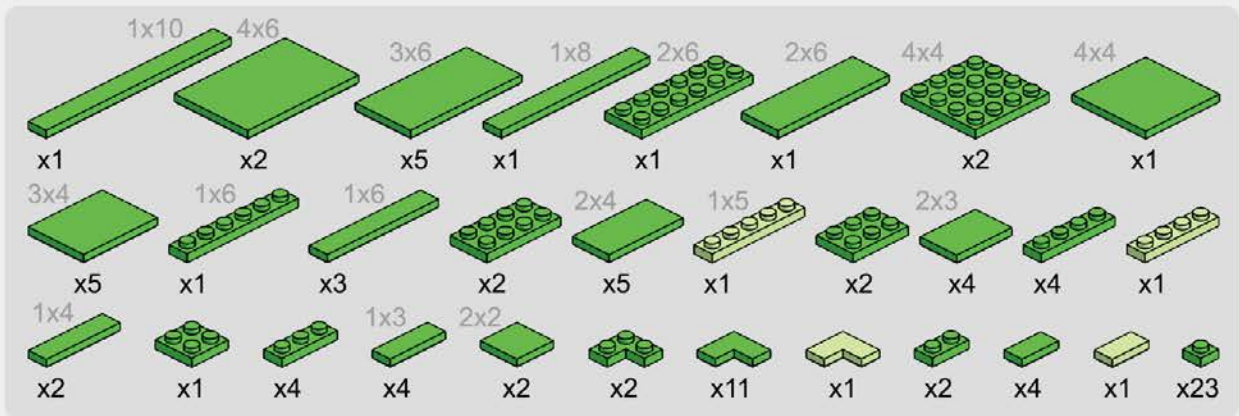

1-5

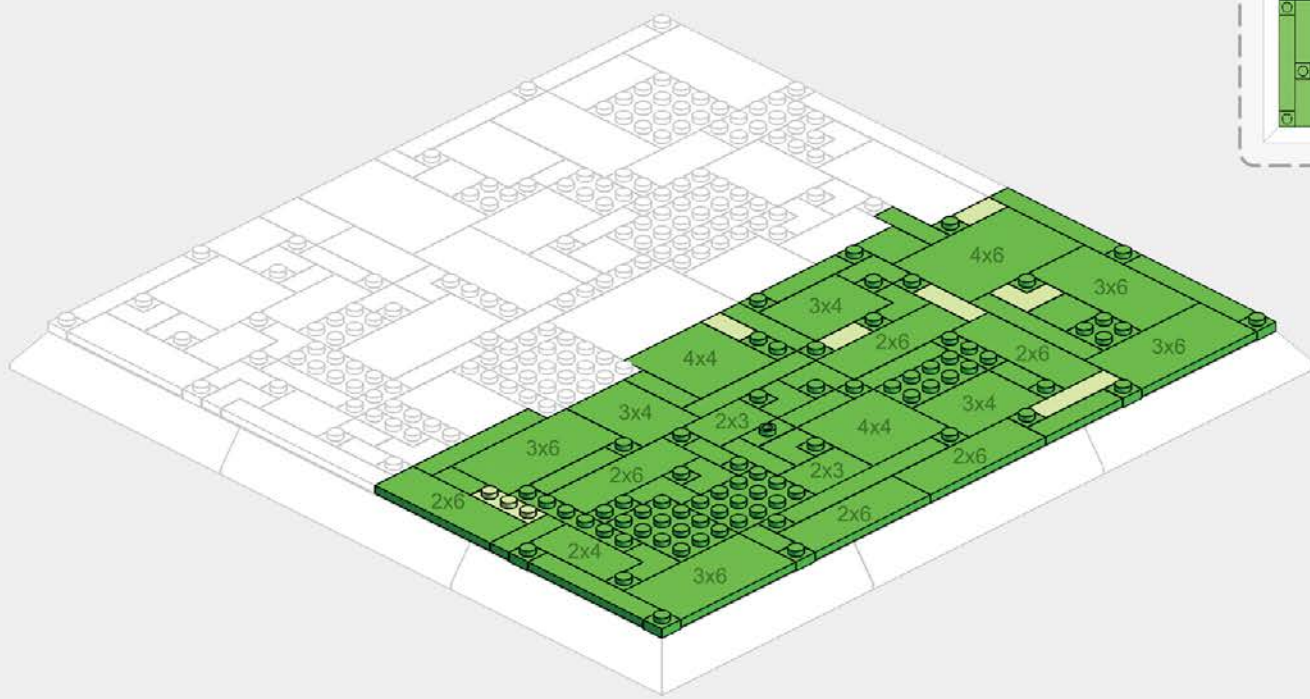
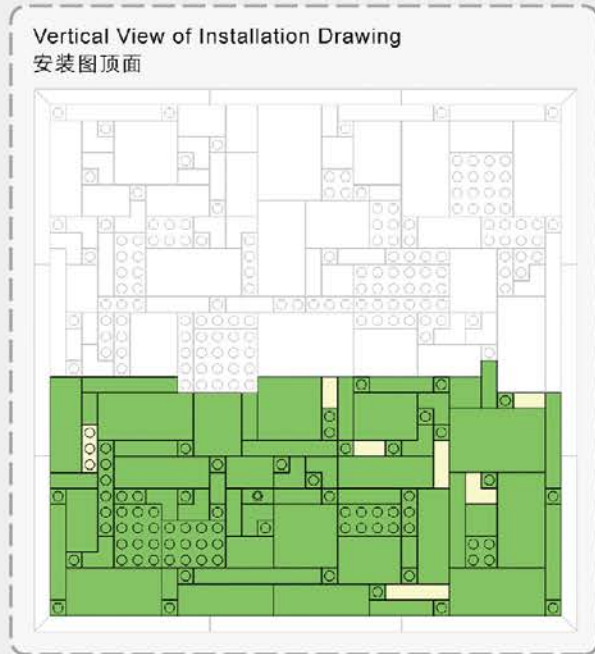
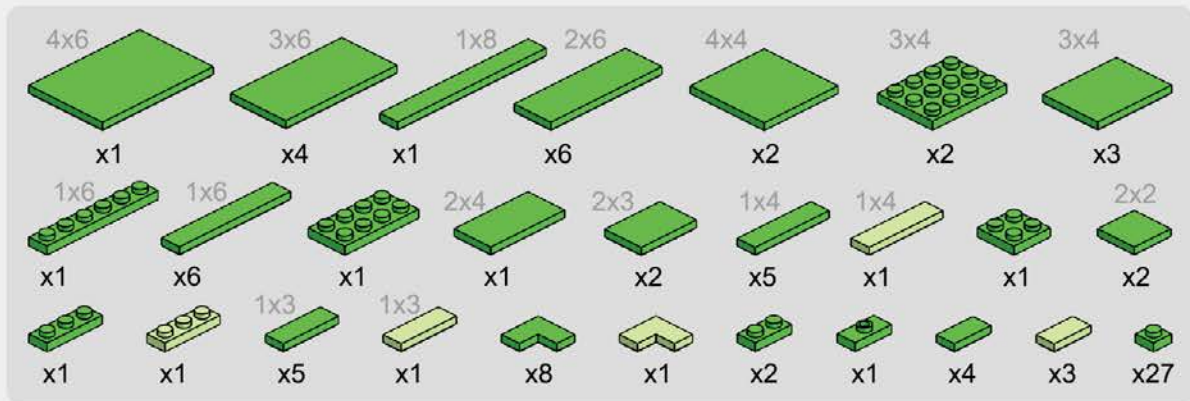



250PCS

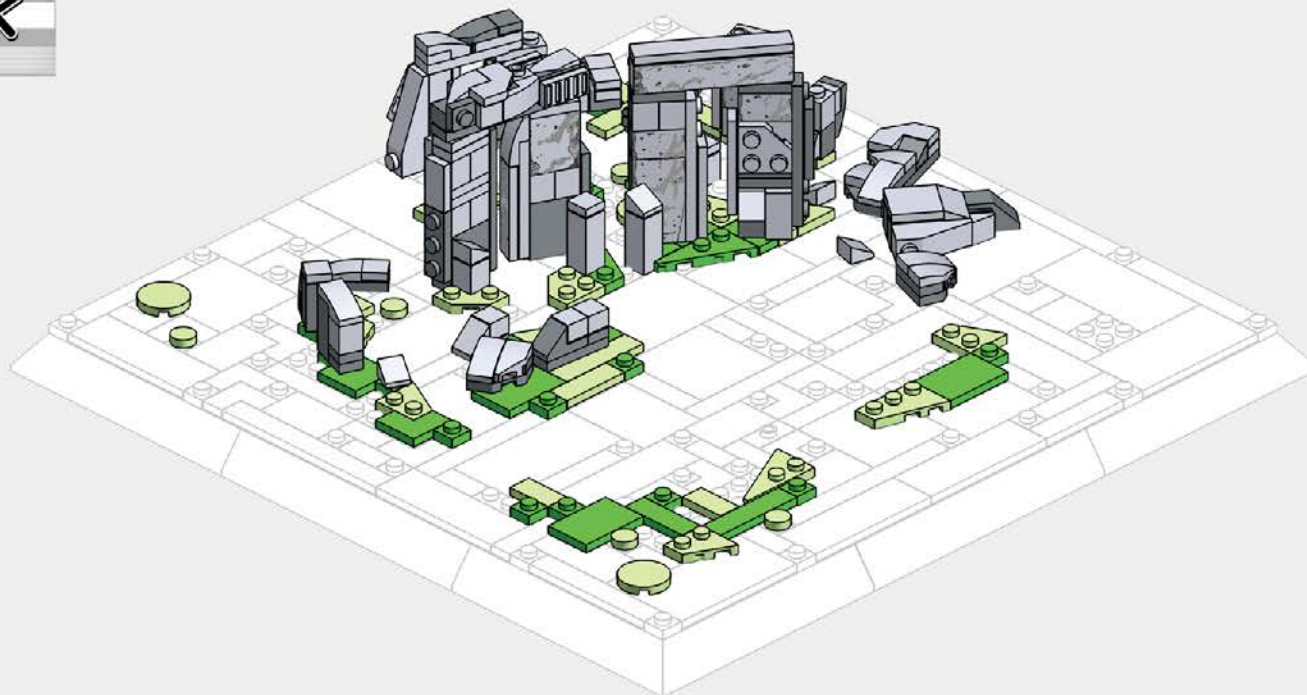

2-1

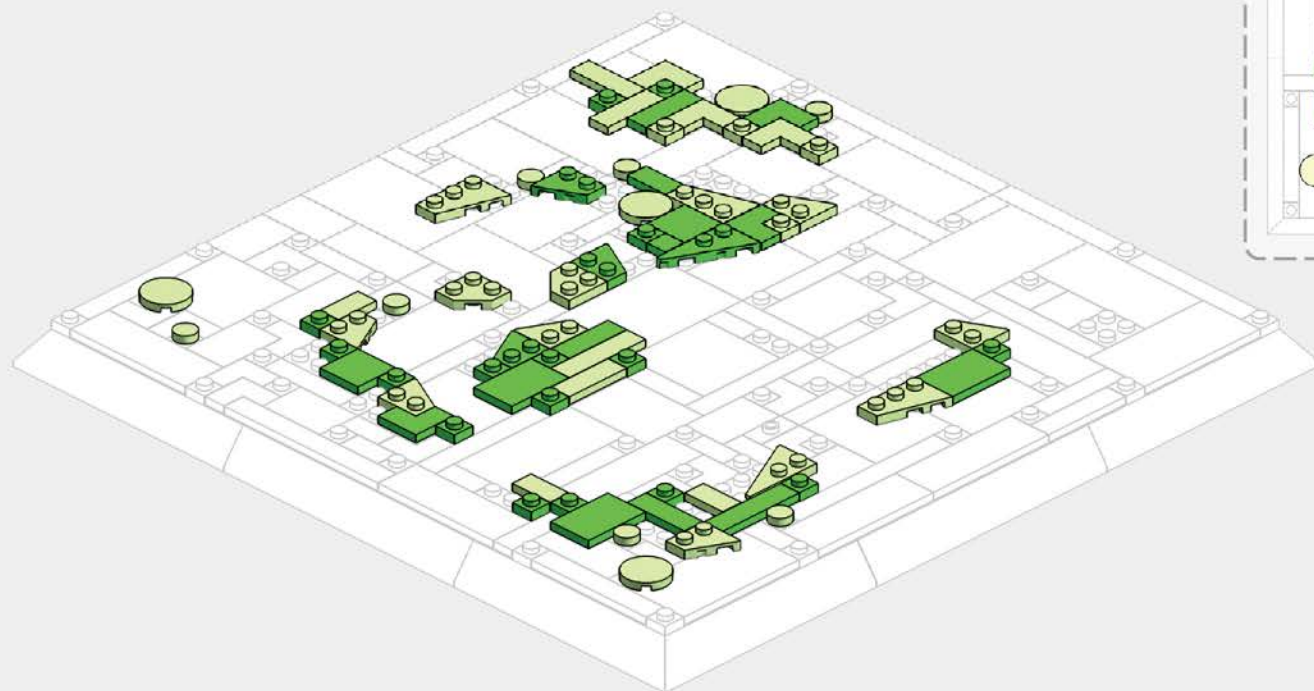
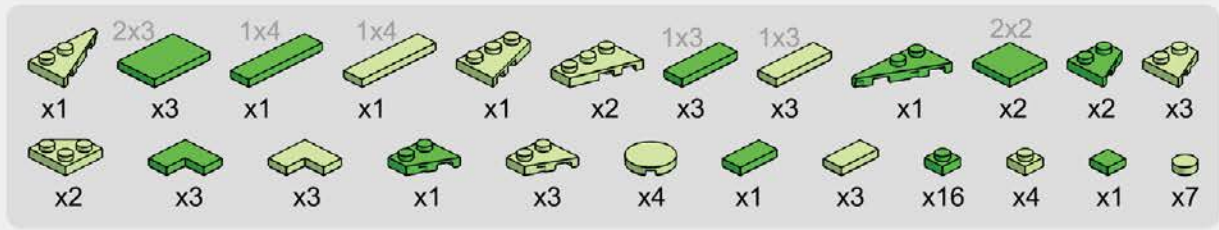

2-3



Vertical View of Installation Drawing
安装图顶面

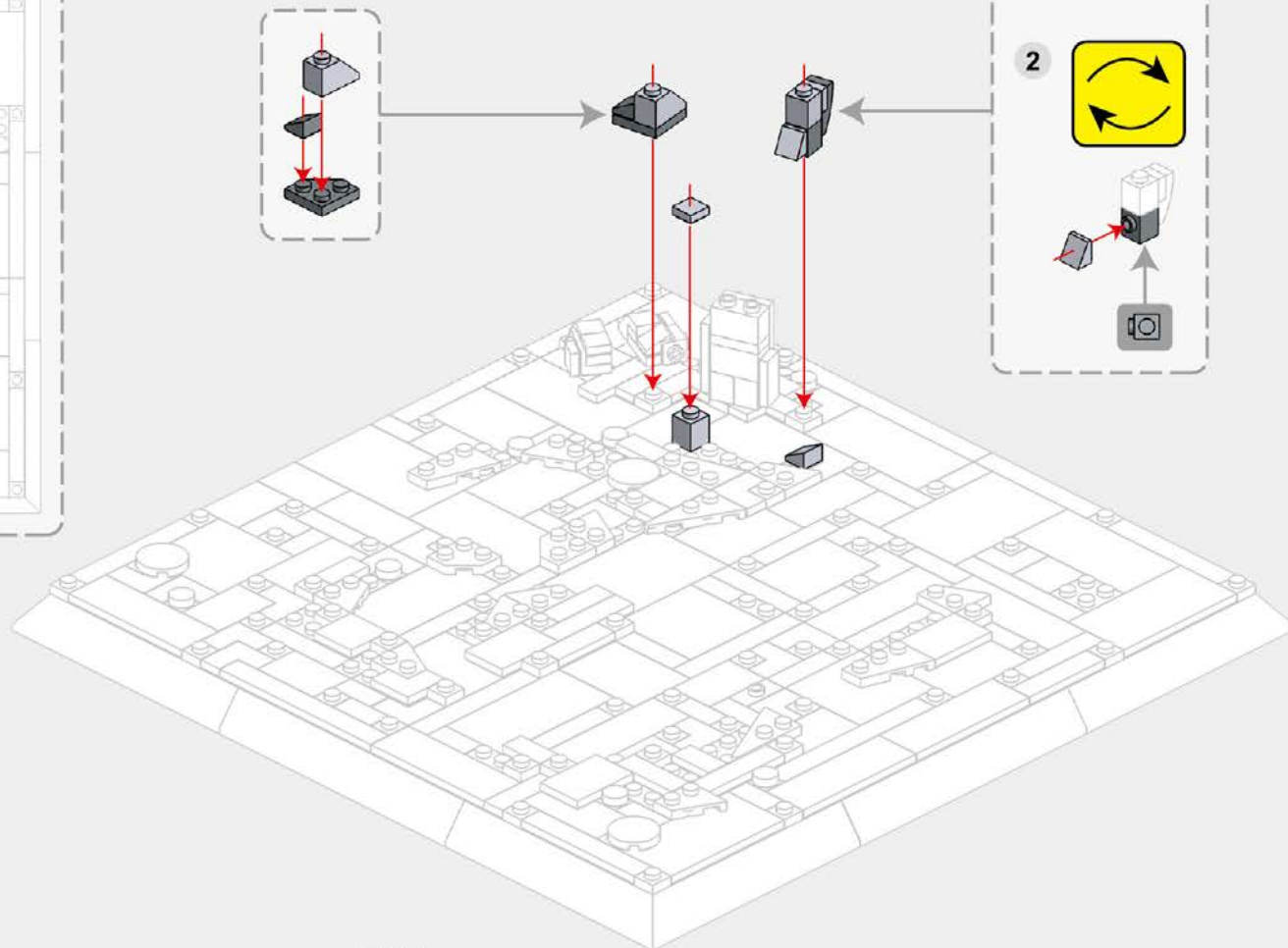
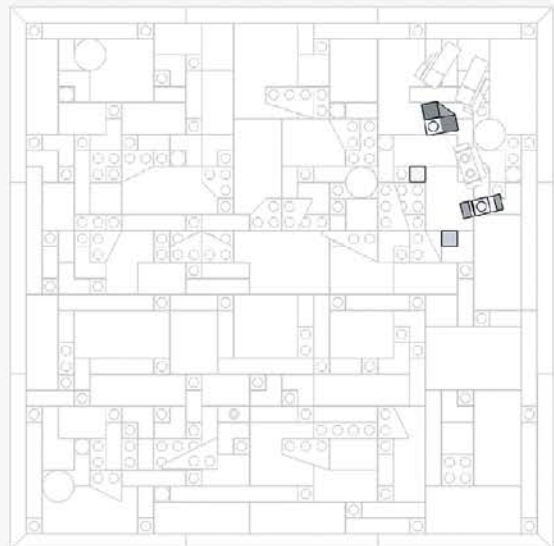

2-4

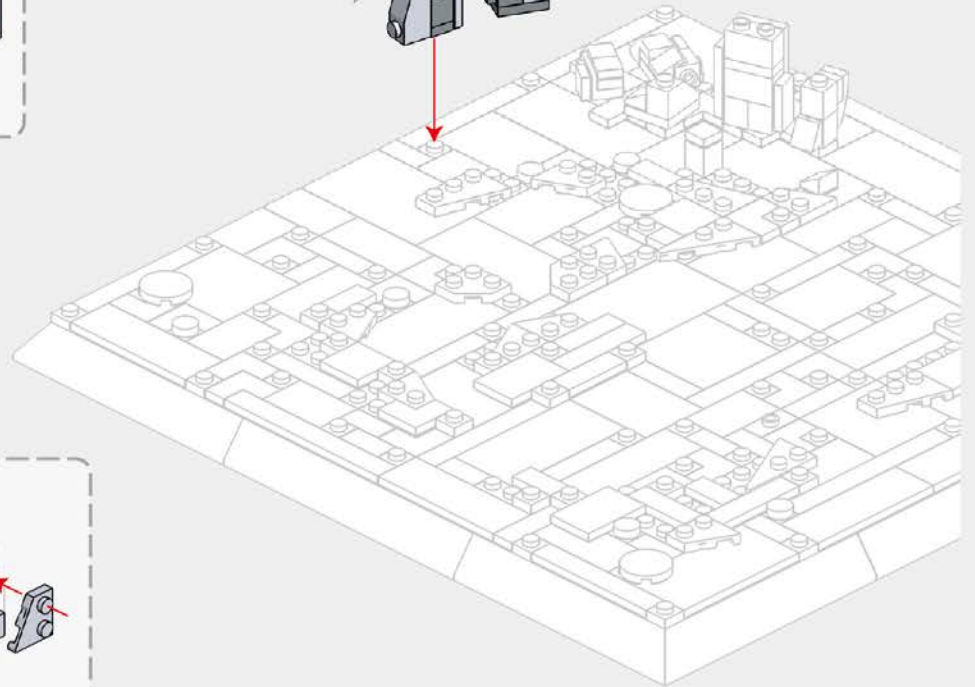
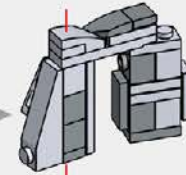
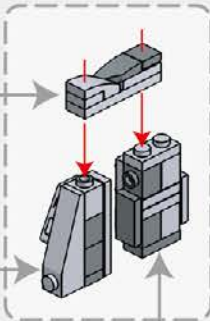
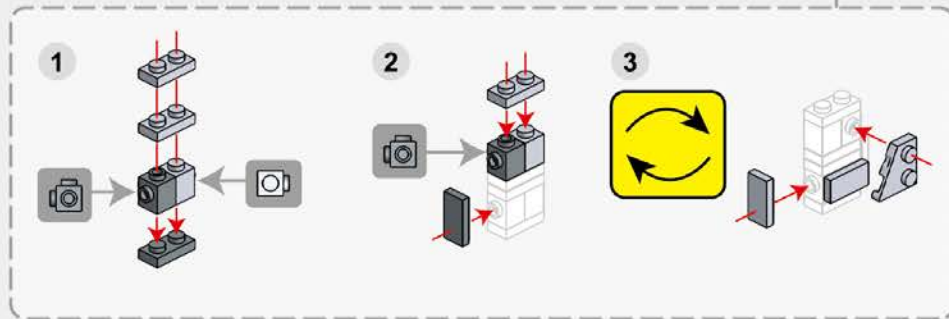
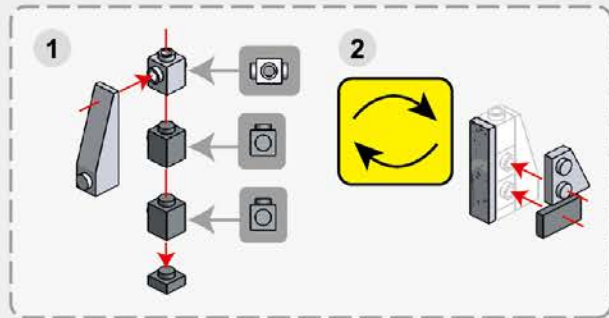
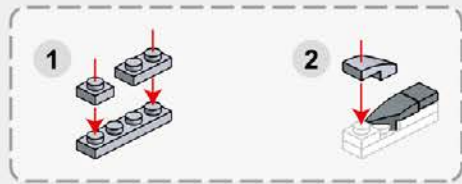

2-5

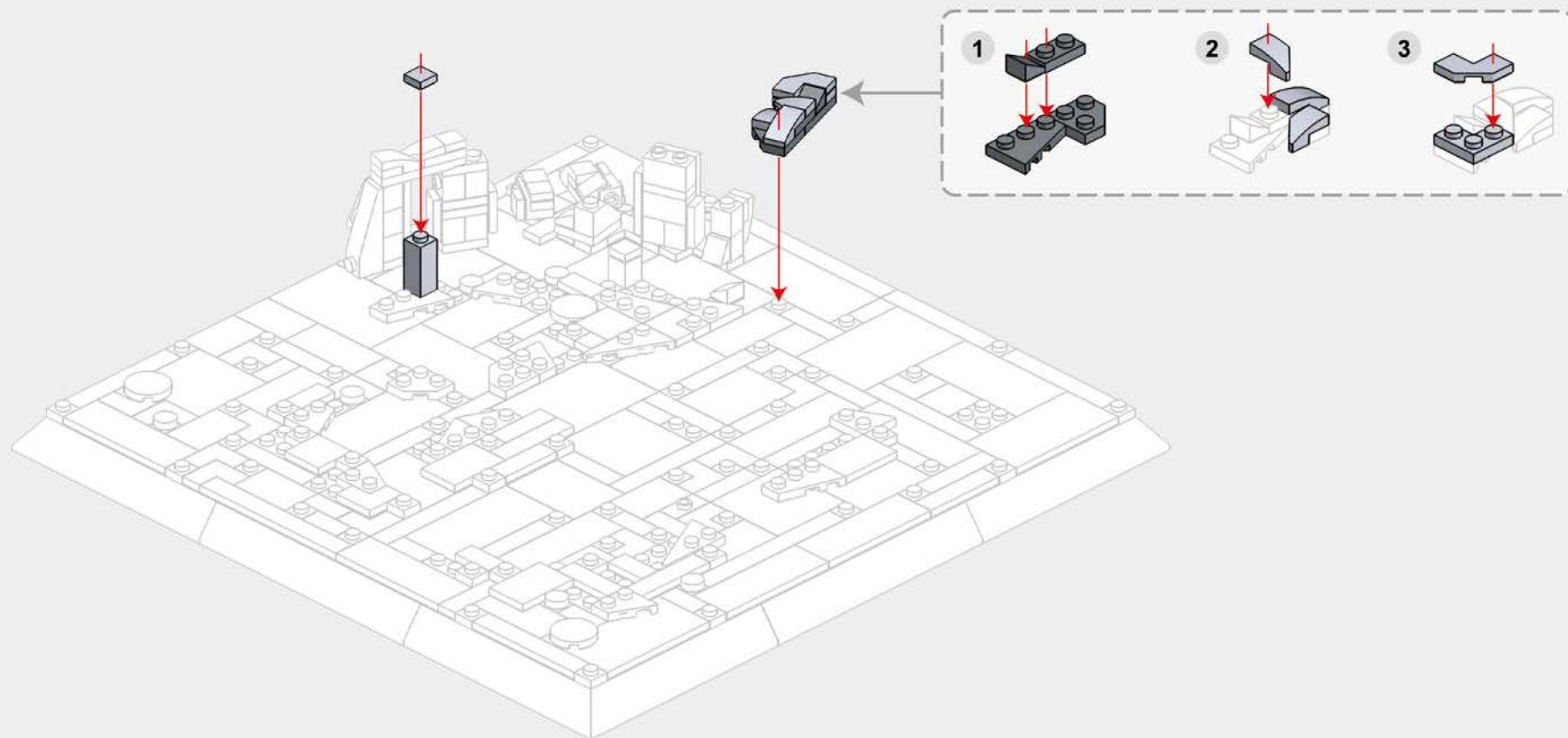
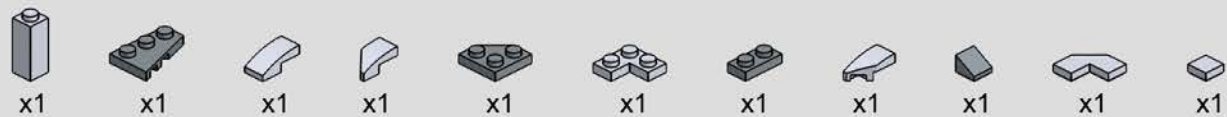

2-7

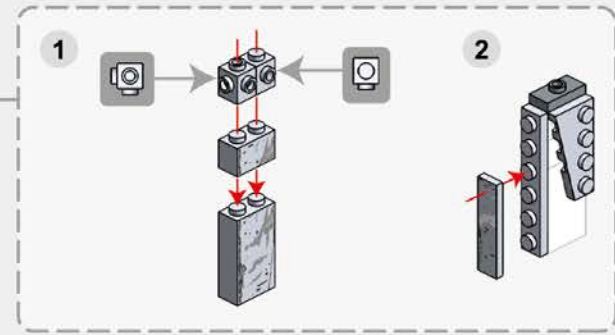
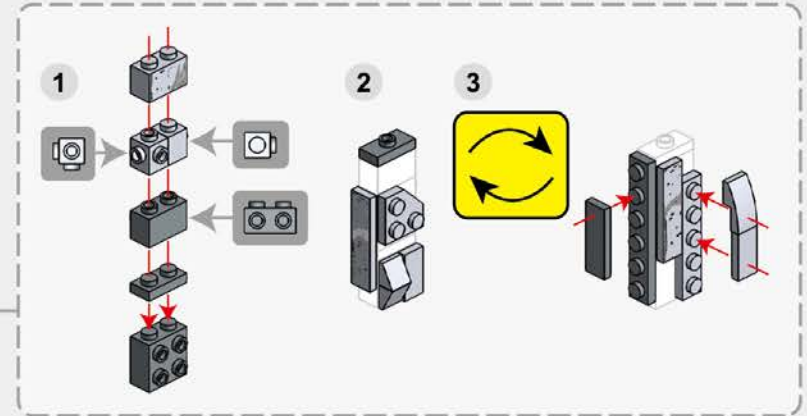
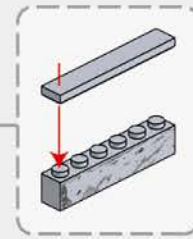
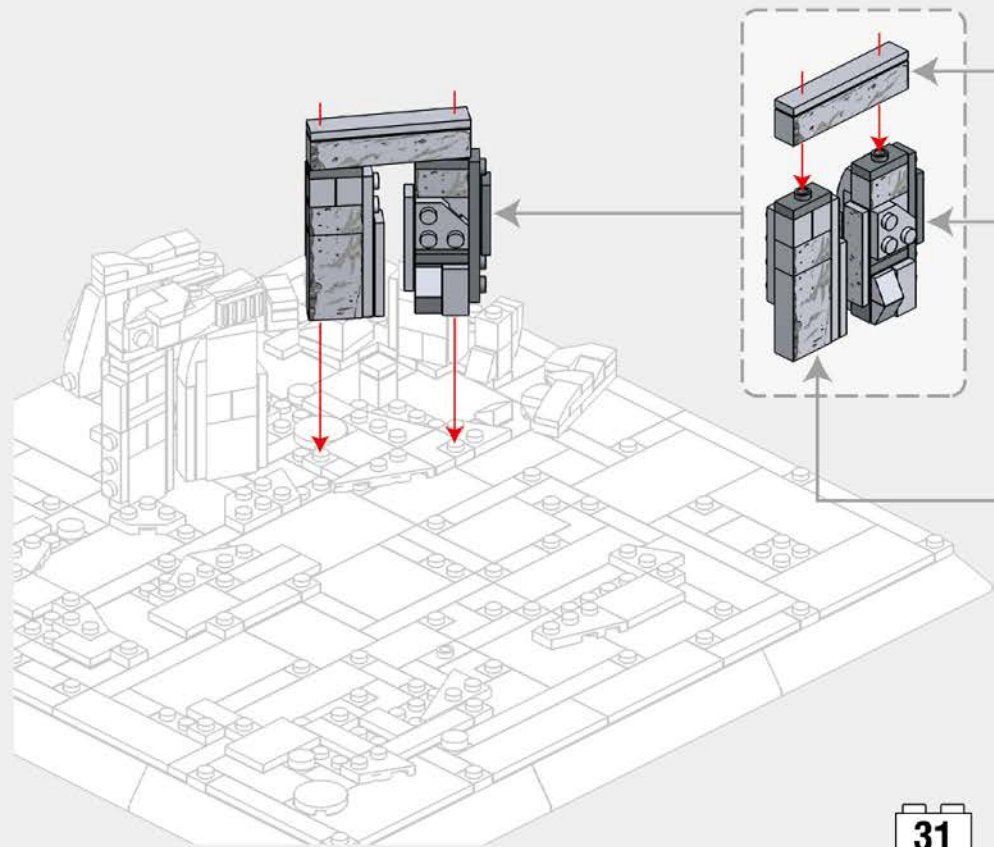
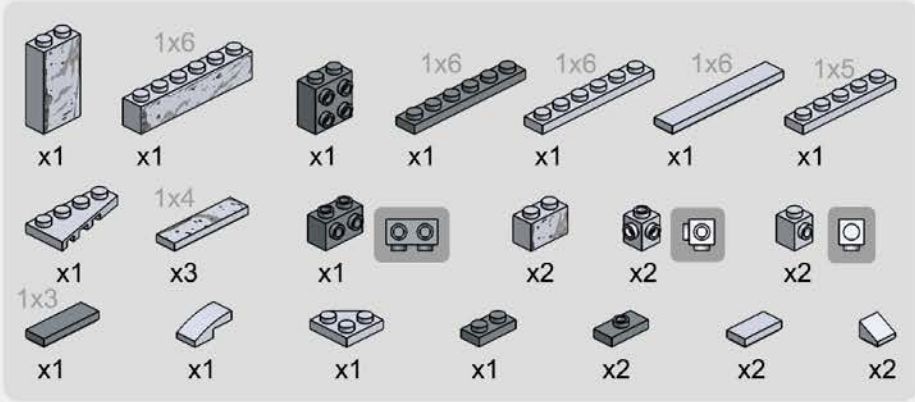

2-8



x2



x1



x1



x1



x2



x2

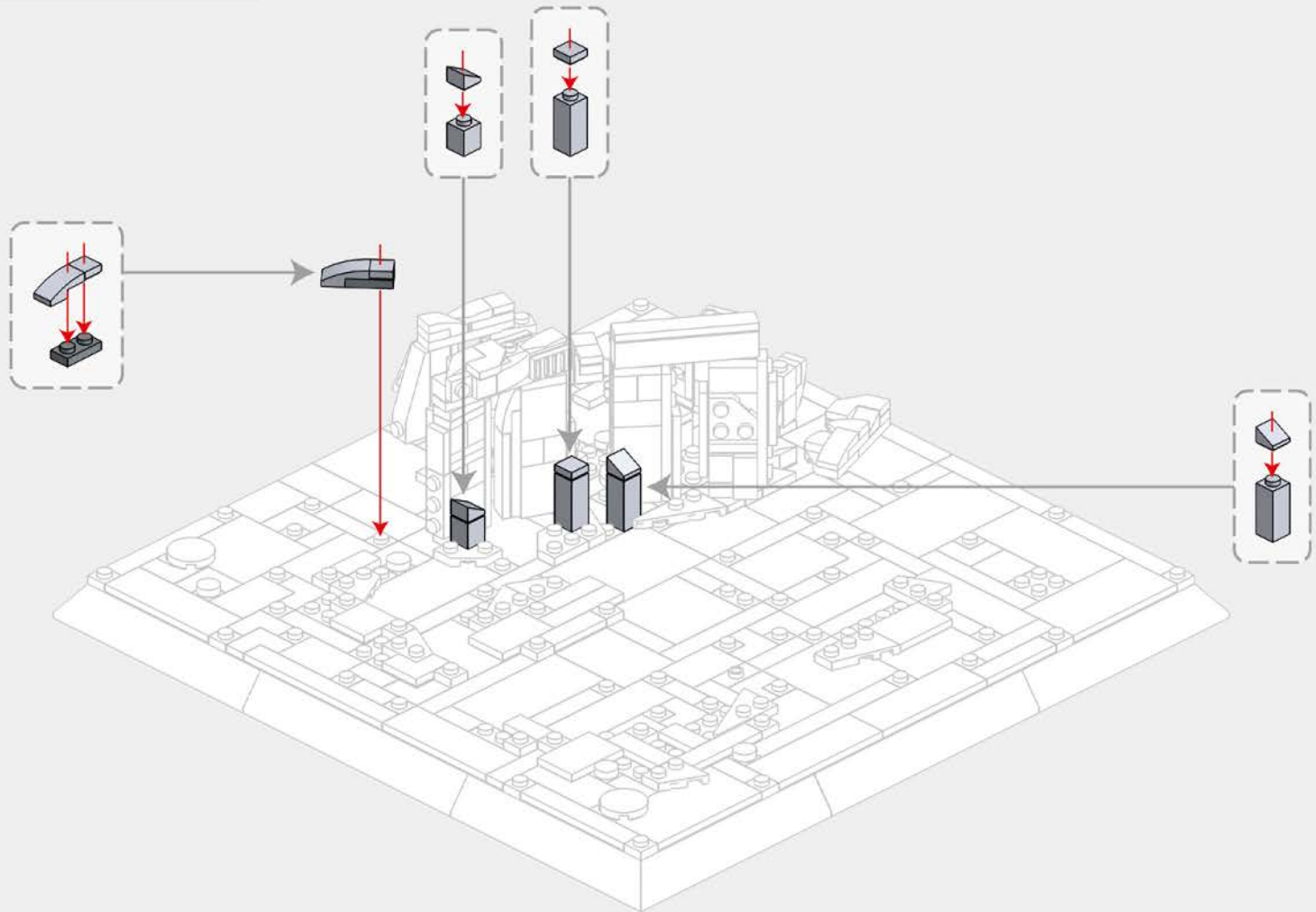

2-9

- x1
- x1
- x1
- x1
- x1
- x1 ^{2x2}
- x1
- x1
- x1
- x1
- x1
- x1
- x1
- x1
- x1
- x3
- x2
- x1
- x2
- x1

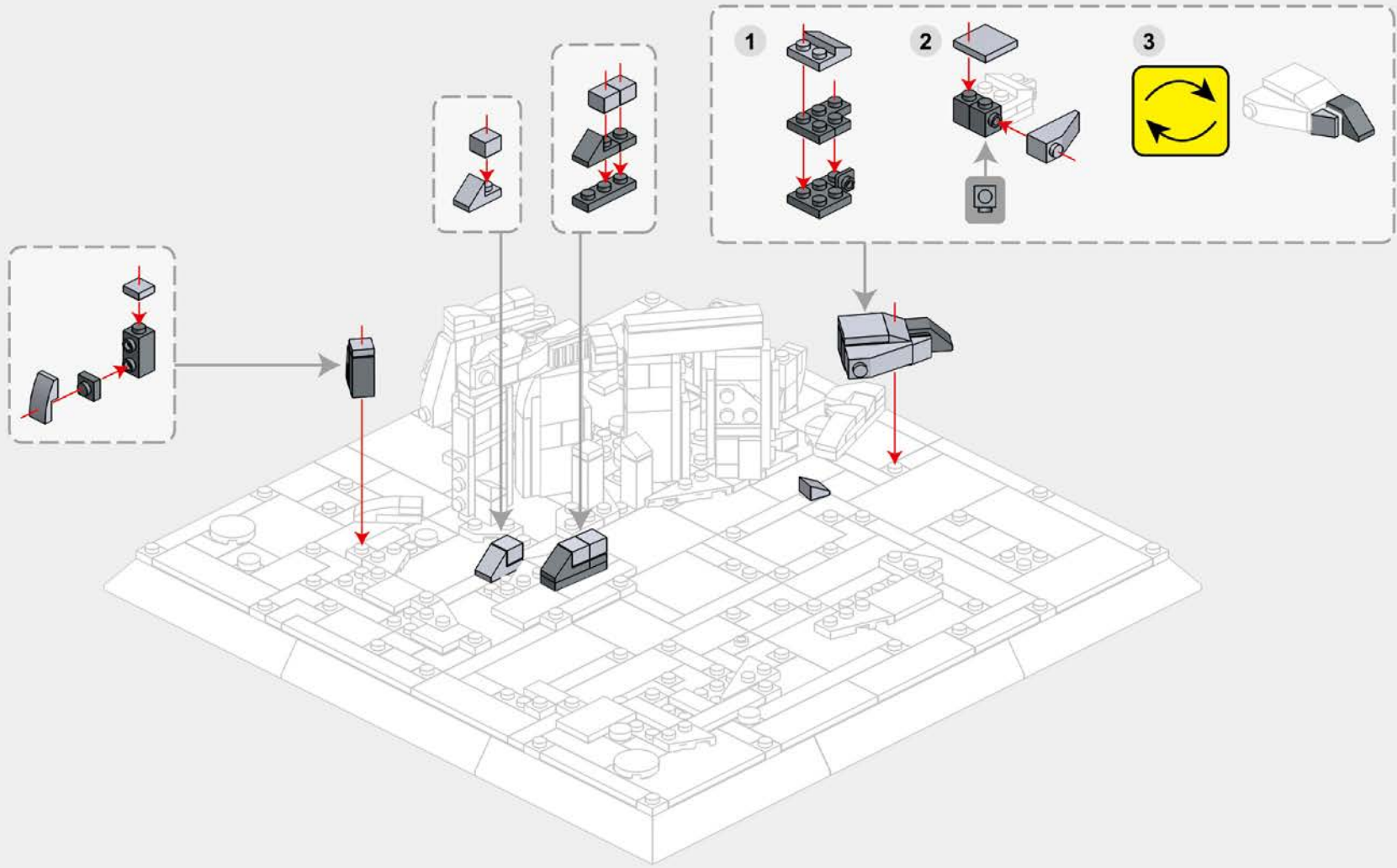

2-10

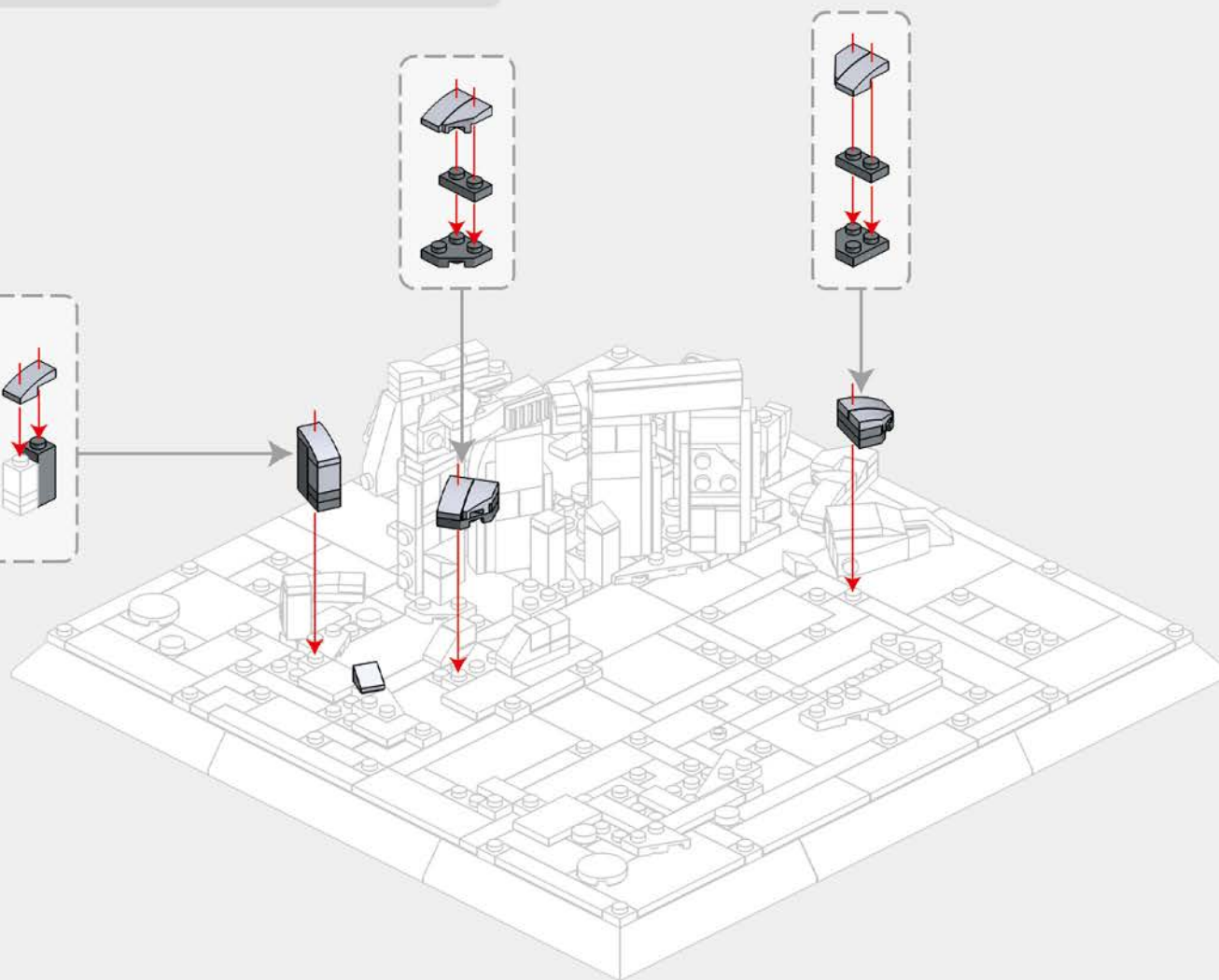
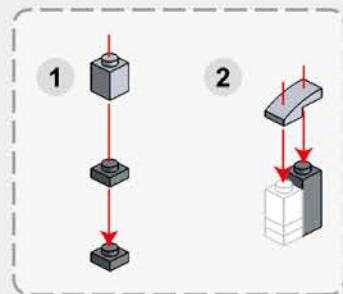



269PCS

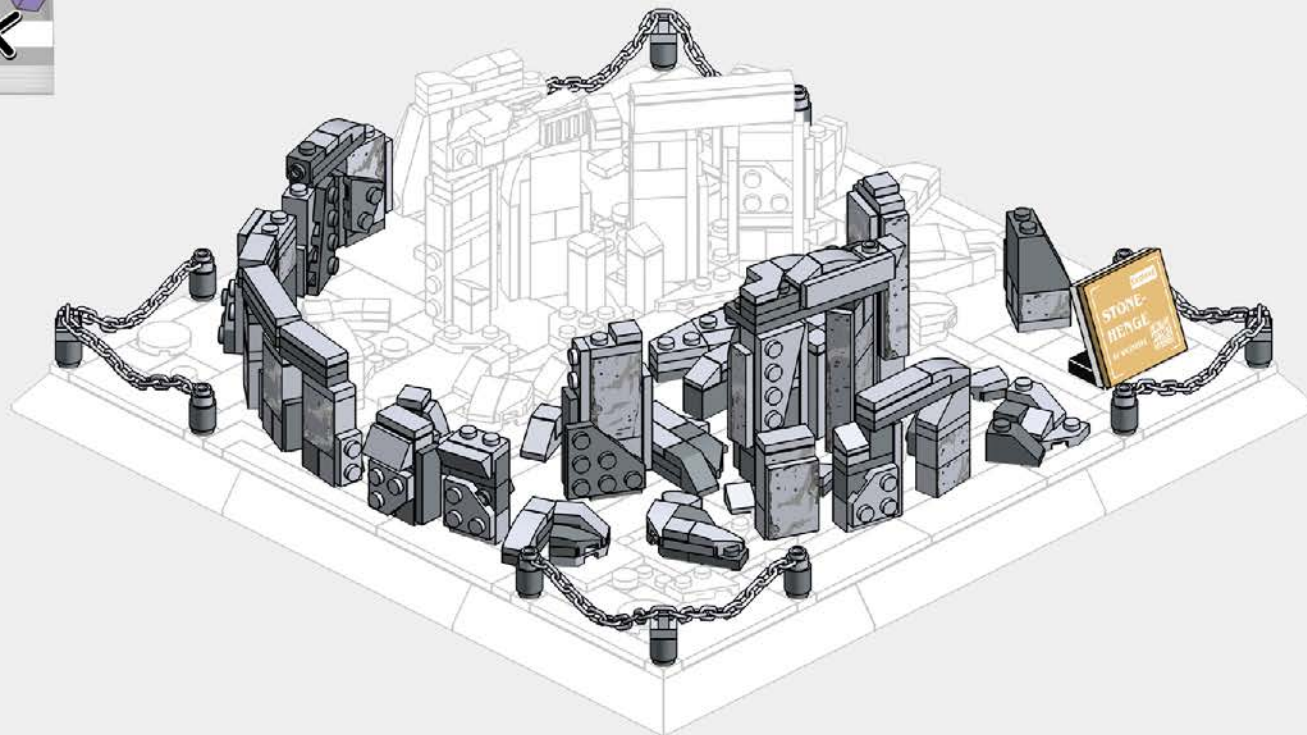

3-3

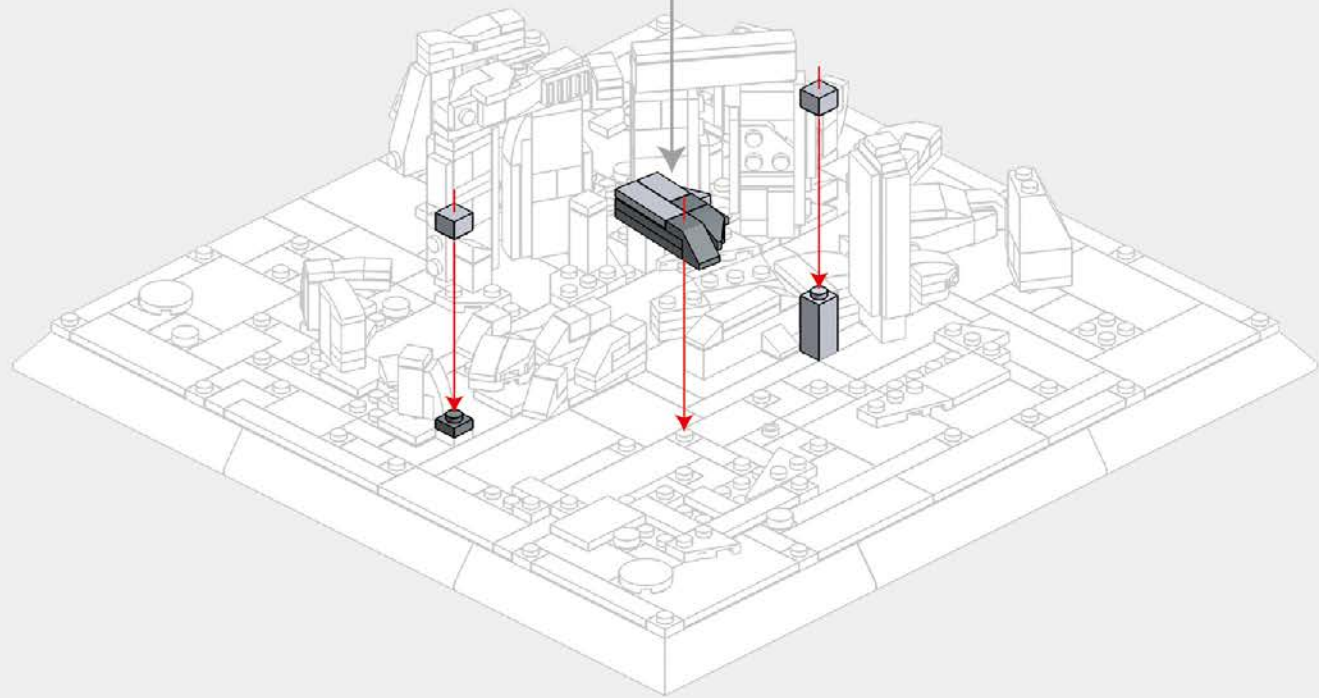
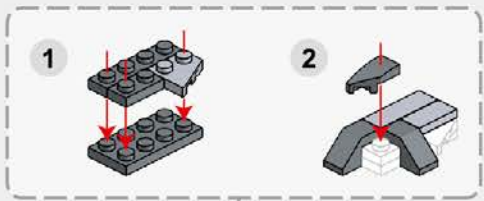
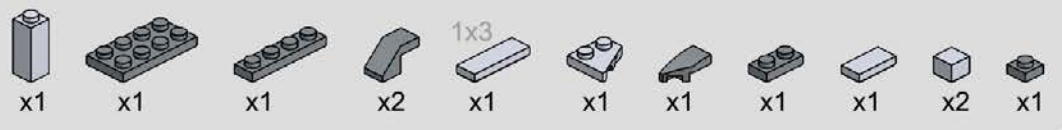

3-4

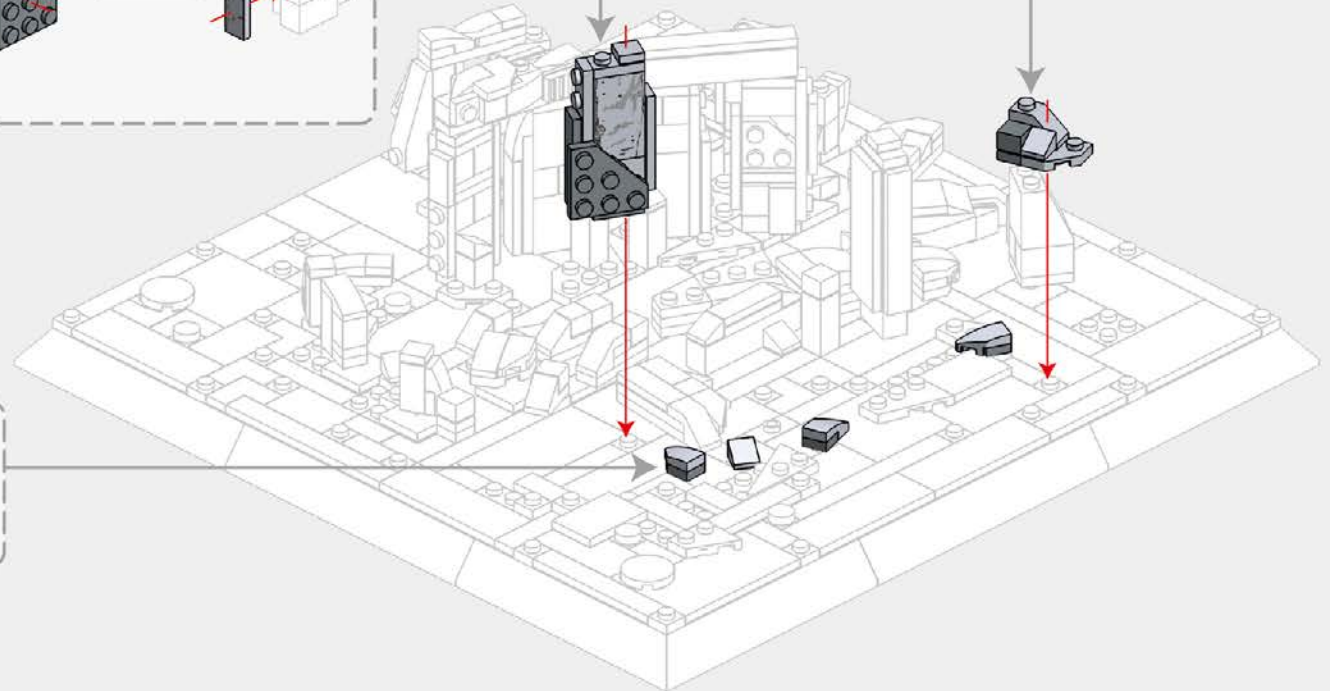
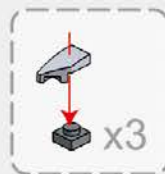
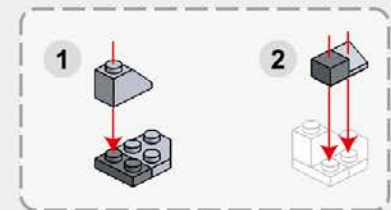
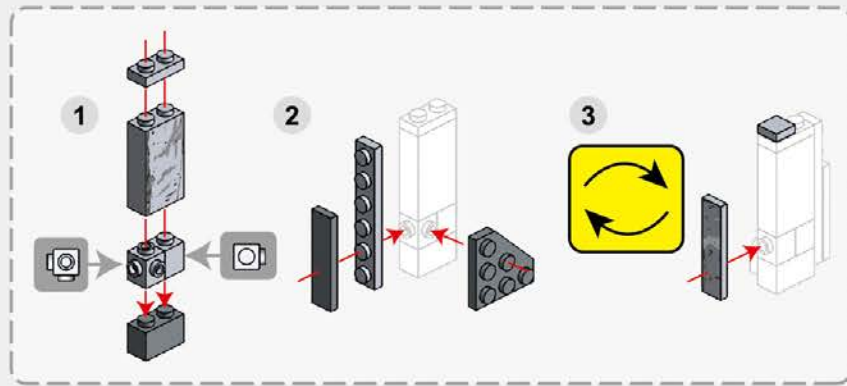

3-5

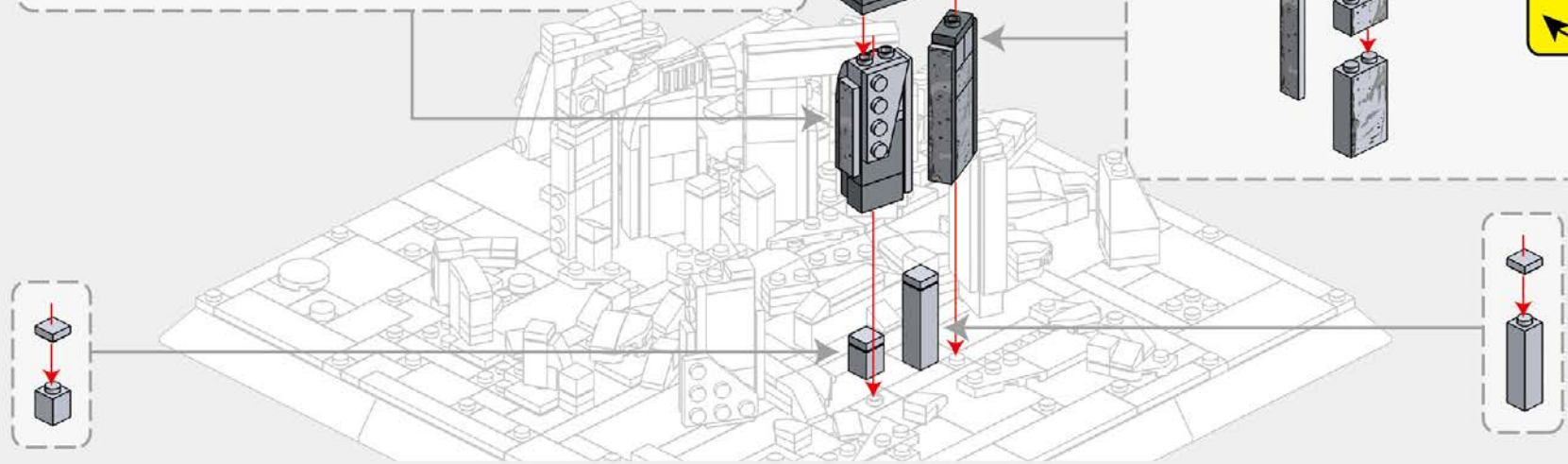
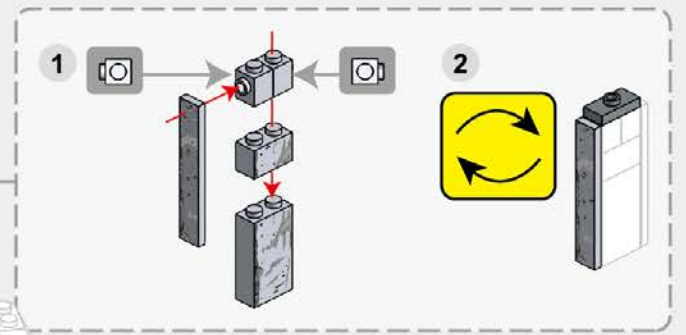
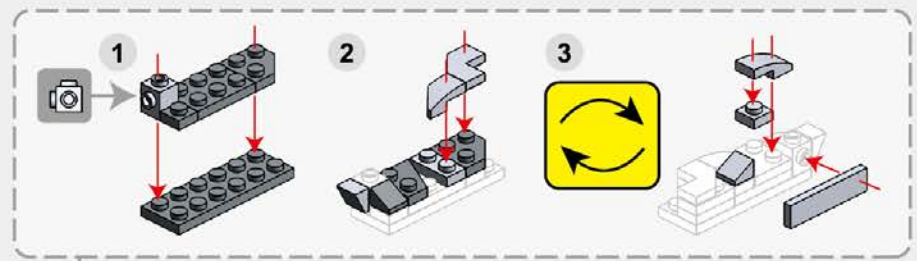
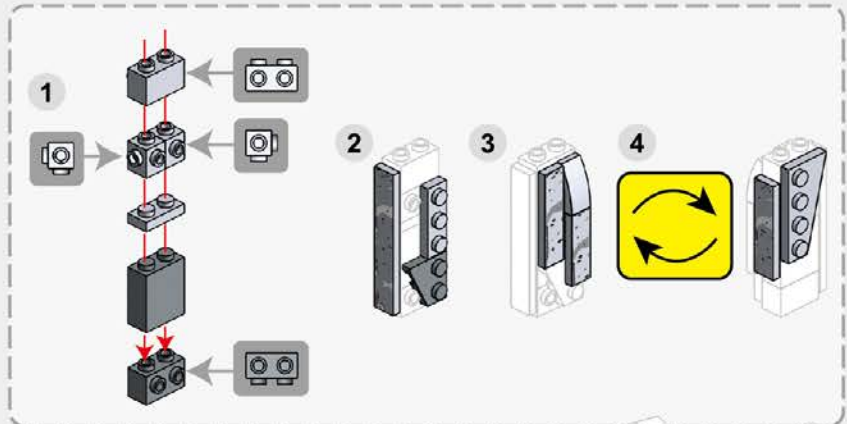
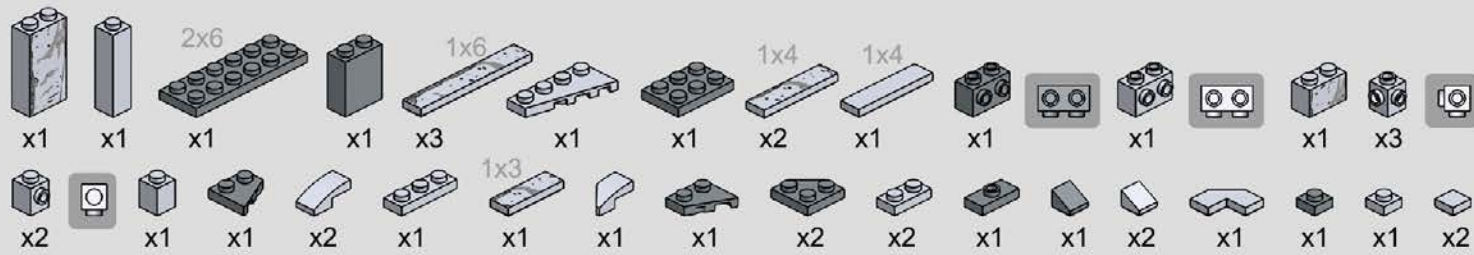

3-6

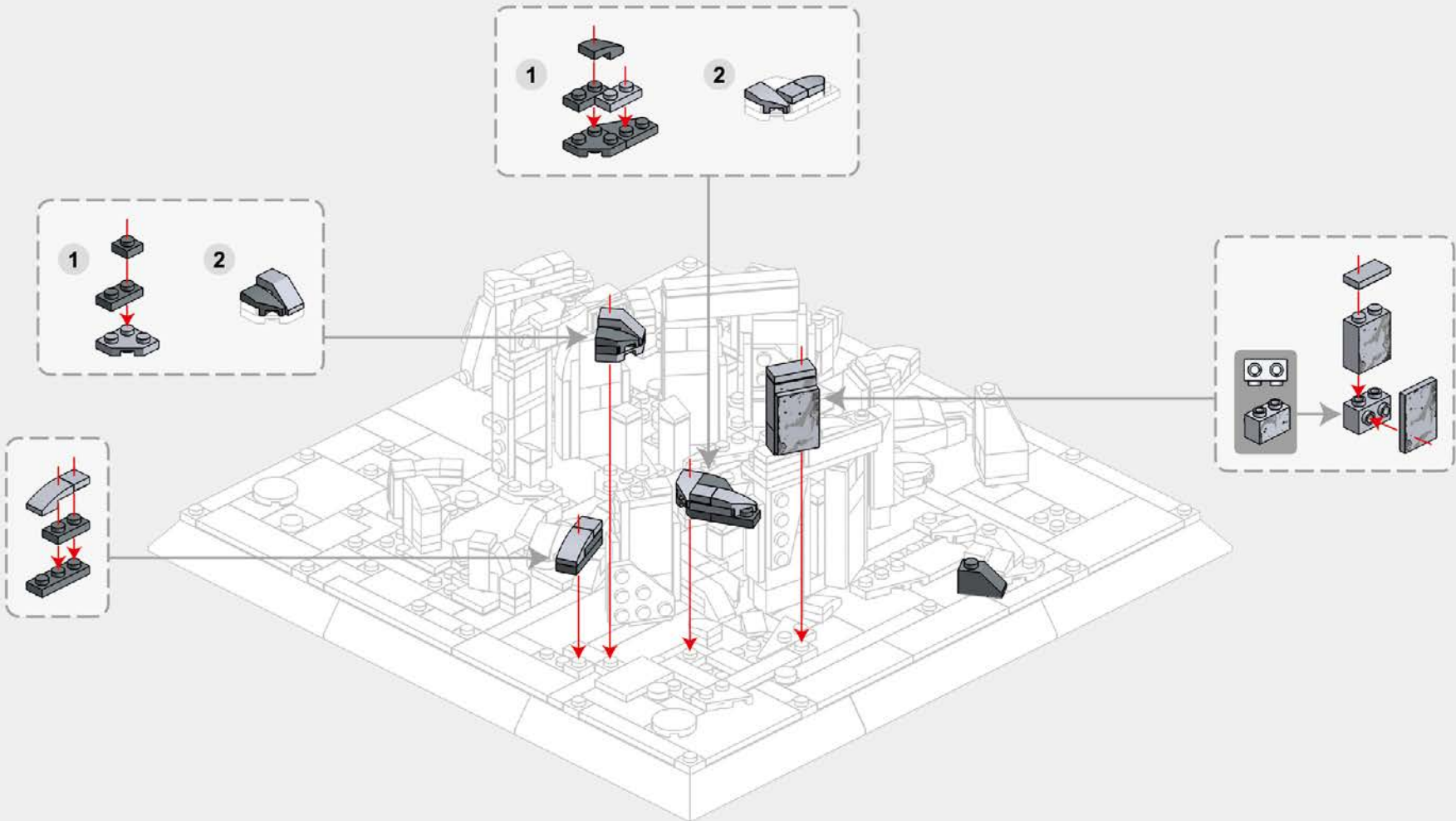
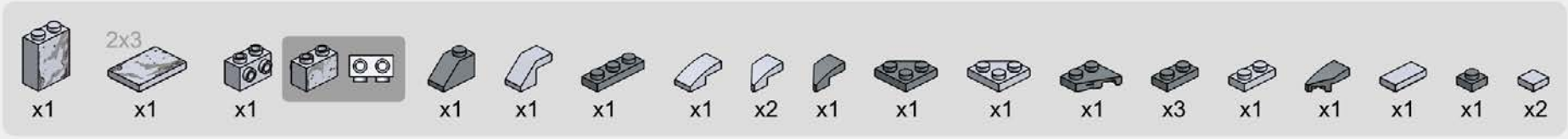

3-7

- 1x5 x1
- 1x4 x1
- 1x4 x1
- 2x2 x1
- 2x2 with hole x1
- 2x2 x2
- 1x3 x1
- 2x2 x2
- 2x2 with hole x1
- 2x2 x1
- 1x3 x1
- 1x3 x1
- 1x3 x1
- 1x3 x1
- 1x3 x1
- 1x3 x1
- 1x3 x1
- 1x3 x1

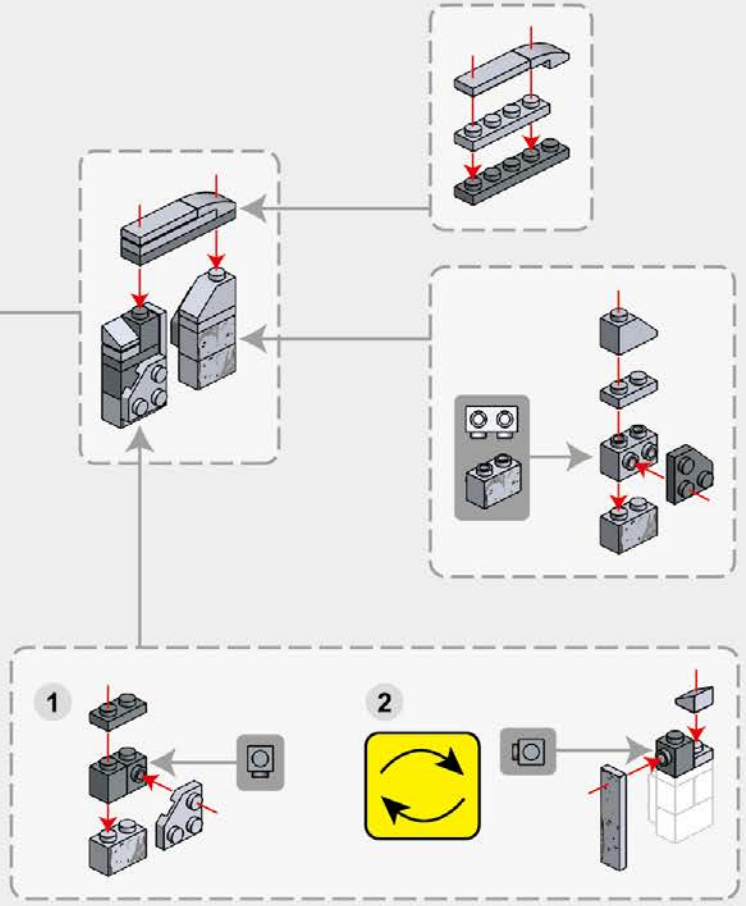
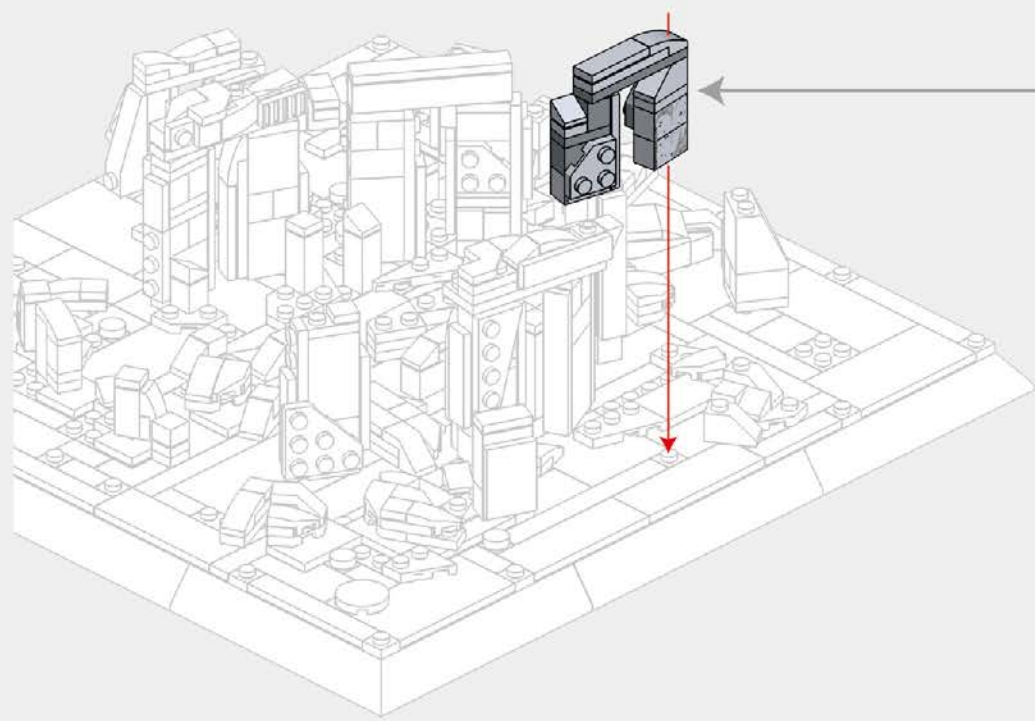

3-8

- x1 [1x3 Technic Beam]
- x3 [1x2 Technic Brick]
- [1x2 Technic Brick with 2 Holes]
- x1 [1x2 Technic Brick]
- [1x2 Technic Brick with 2 Holes]
- x1 [1x2 Technic Brick]
- x1 [1x2 Technic Brick]
- x1 [1x3 Technic Beam]
- x1 [1x2 Technic Brick]
- [1x2 Technic Brick with 2 Holes]
- x1 [1x2 Technic Brick]
- [1x2 Technic Brick with 2 Holes]
- x2 [1x2 Technic Brick]
- x2 [1x2 Technic Brick]
- x1 [1x2 Technic Brick]
- x1 [1x2 Technic Brick]

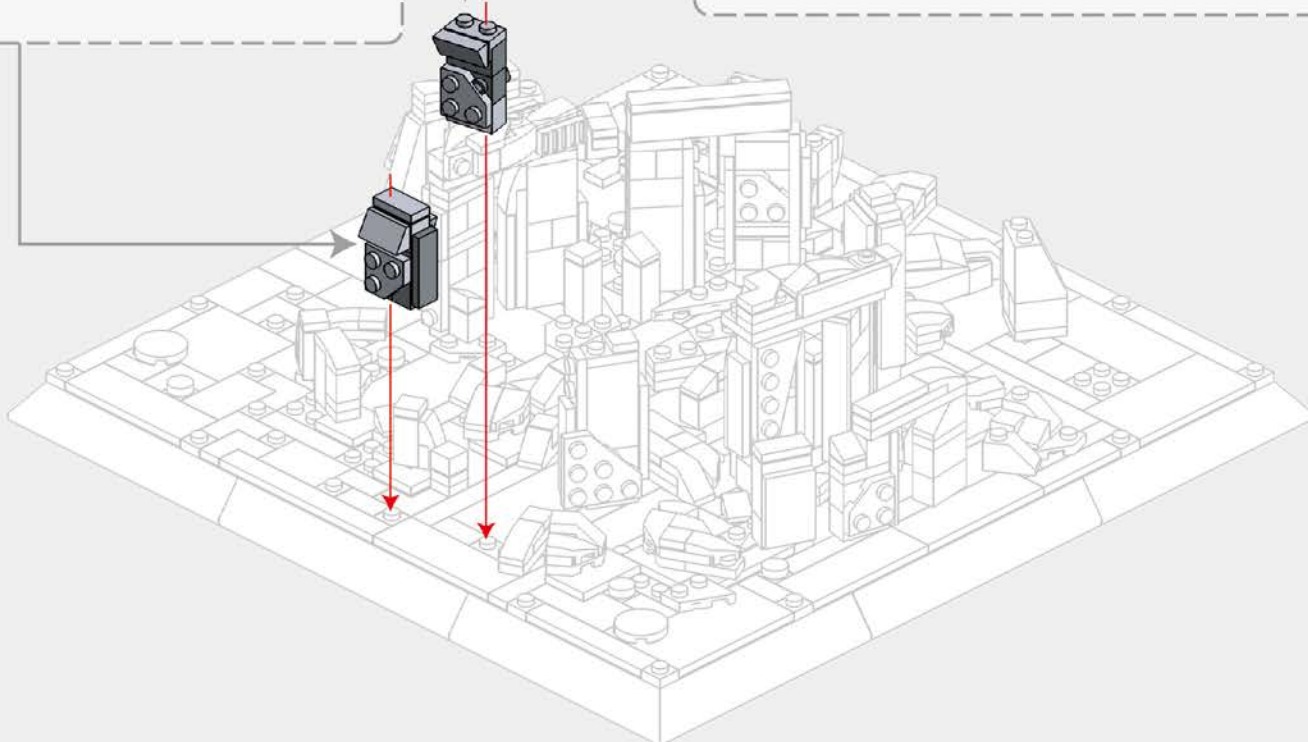
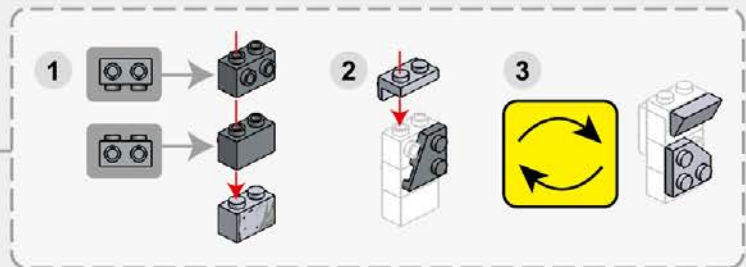
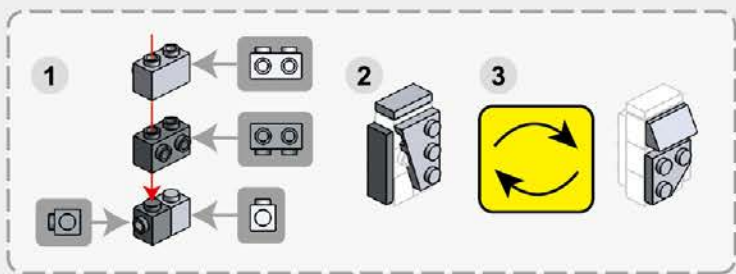

3-10

- x1
- x2
- x1
- x1
- x1
- x1
- x3
- x1
- x1
- x1
- x1
- x2
- x2
- x1
- x1

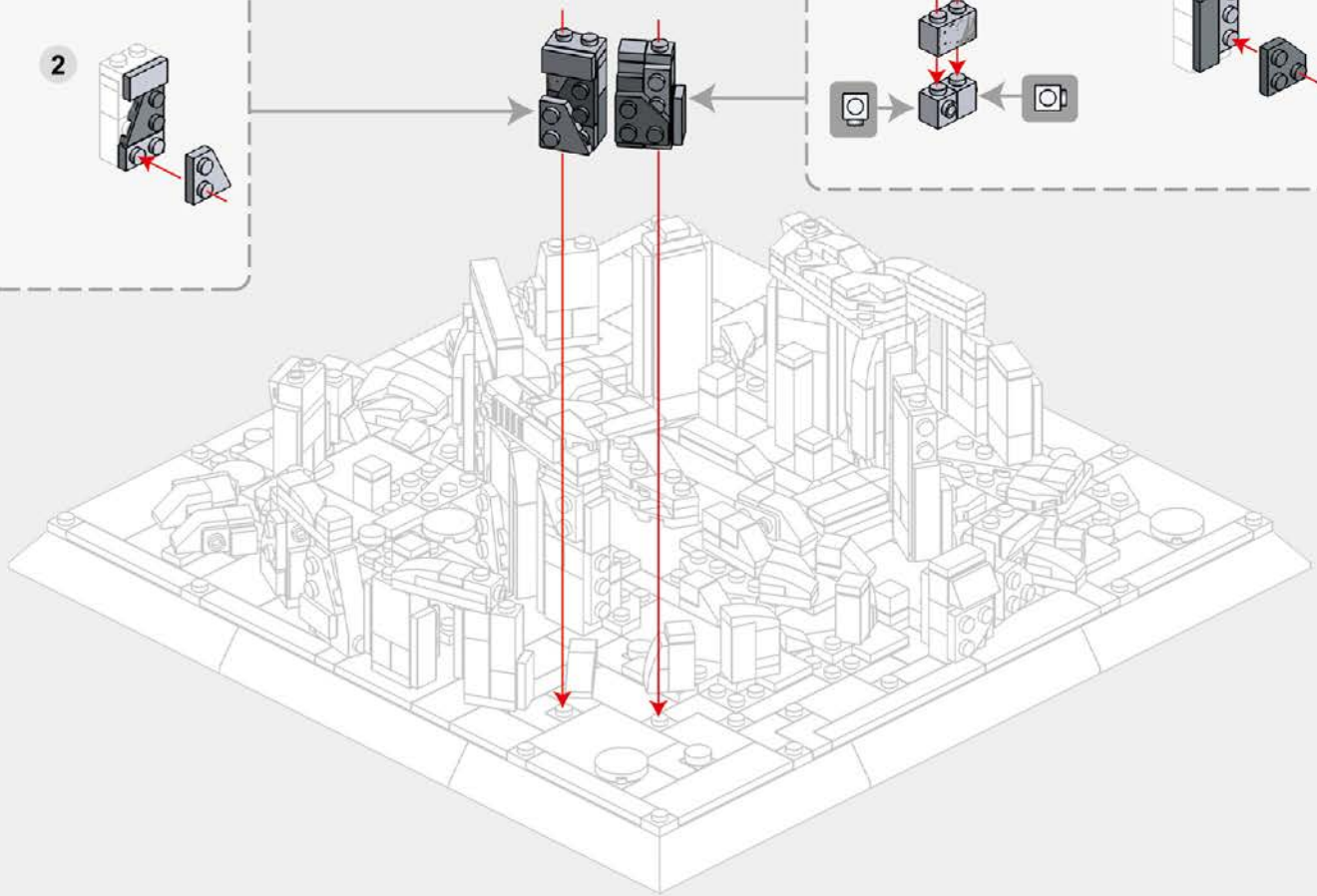
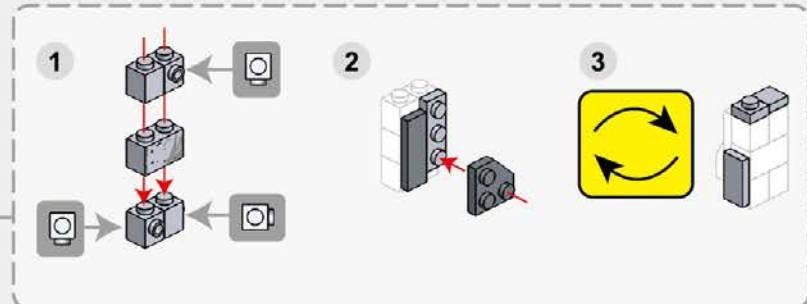
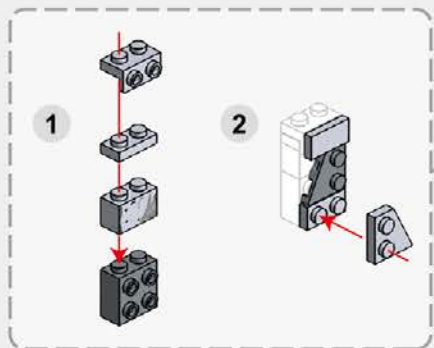

3-12

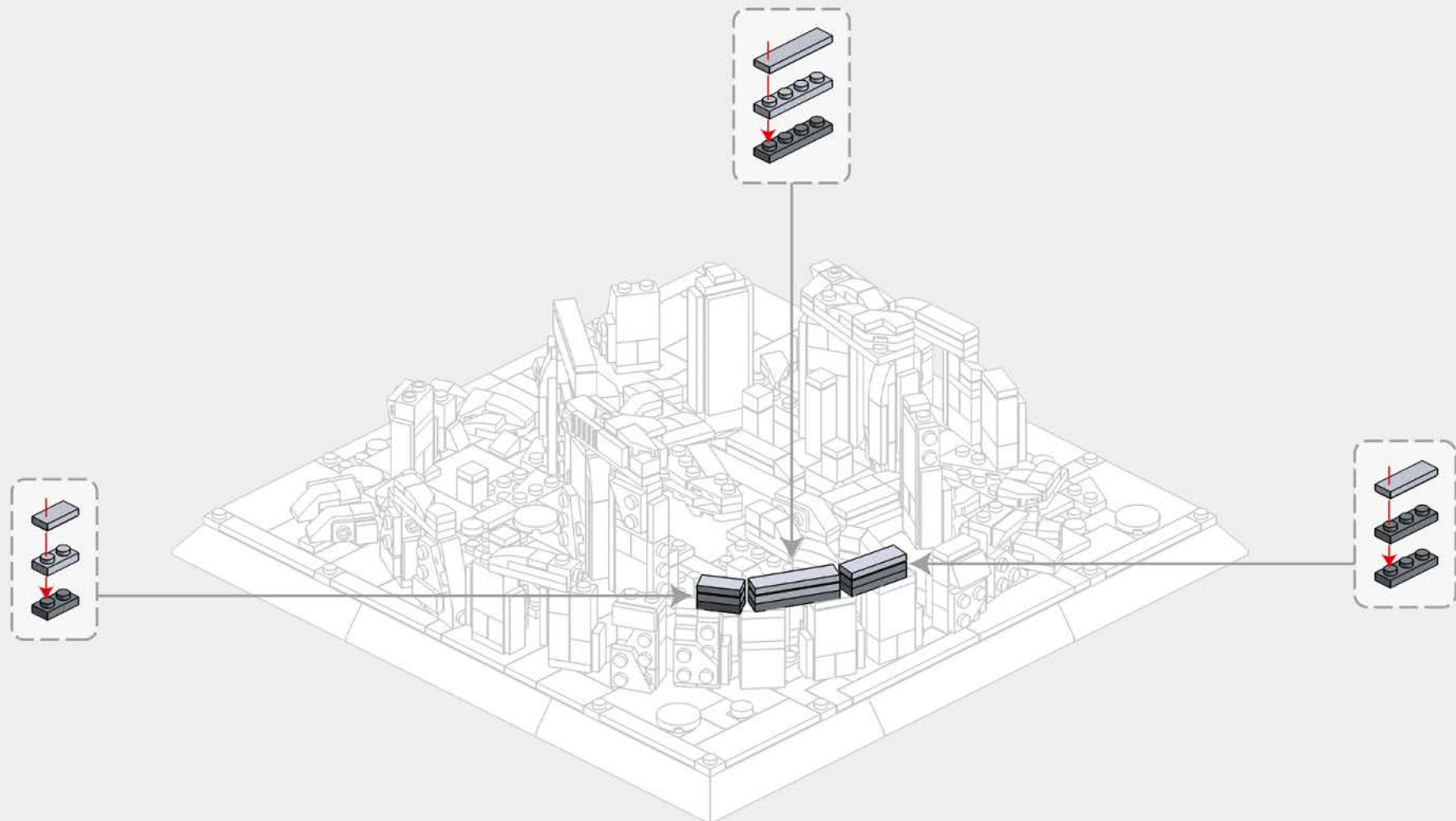
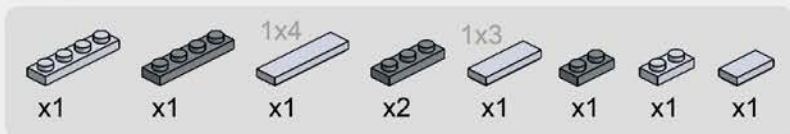

3-13

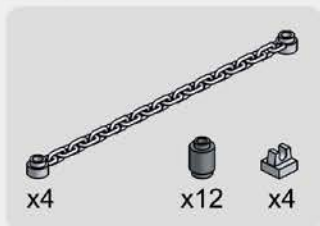

x4

x12

x4

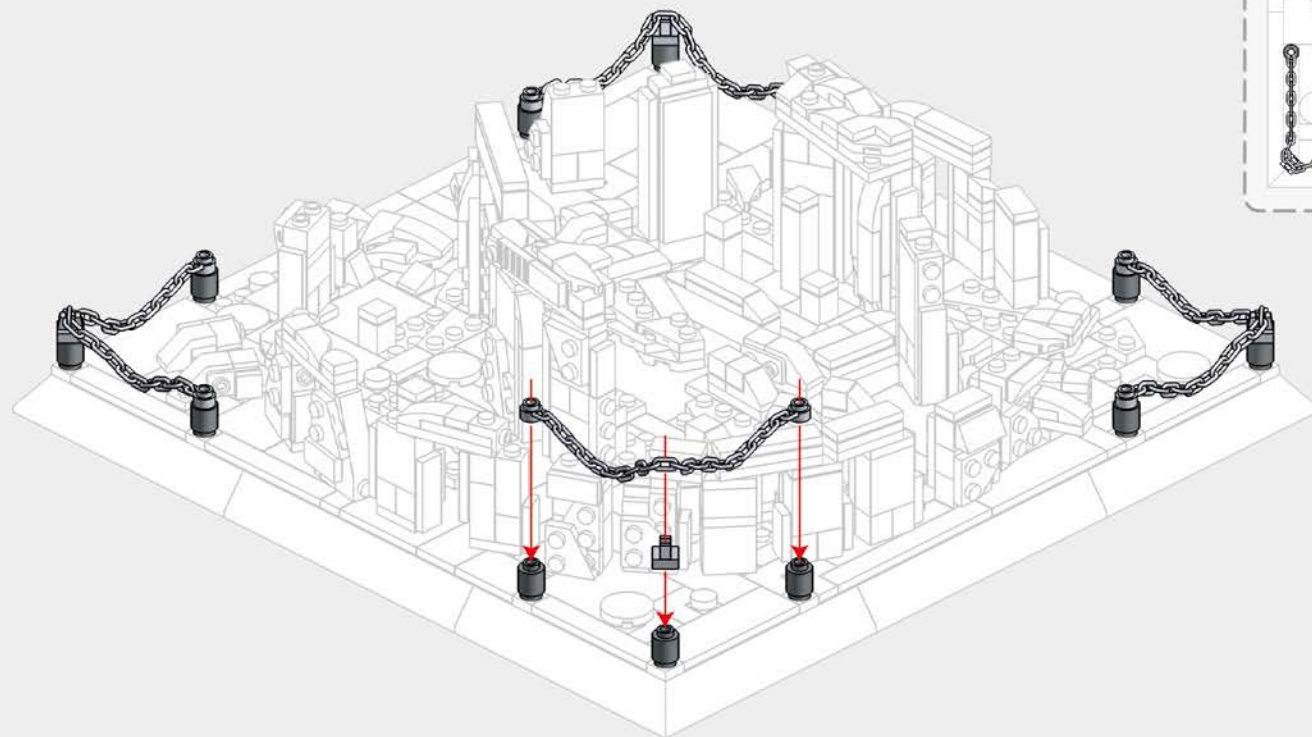

Vertical View of Installation Drawing
安装图顶面

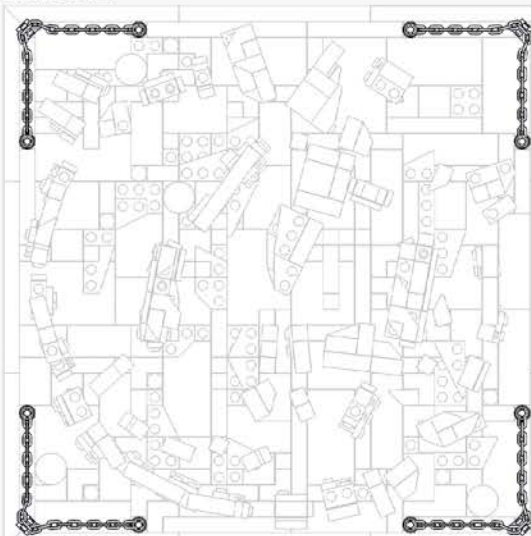

3-14

